

DryTC165

DryTC650

LiquidTC165

LiquidTC255

Temperature Calibrators
Instruction Manual



Introduction

This technical manual provides operating instructions for the Druck DryTC and LiquidTC Series temperature calibrators.

Scope

This technical manual contains a brief description, operation and testing procedures for the user of this equipment.

Safety

The manufacturer has designed this equipment to be safe when operated using the procedures detailed in this manual:

- Do not use this equipment for any other purpose than that stated. Incorrect use can prevent the protection given by the equipment from working.
- Use suitably qualified¹ Technicians and good engineering practice for all procedures in this publication.

Maintenance







The equipment must be maintained using the manufacturer's procedures and should be carried out by authorized service agents or the manufacturer's service departments.

Technical Advice

For technical advice contact Druck or subsidiary manufacturer of this product.

1. A qualified technician must have the necessary technical knowledge, documentation, special test equipment and tools to carry out the required work on this equipment.

Marks and Symbols on the Equipment

Symbol	Description
	This equipment meets the requirements of all relevant European safety directives. The equipment carries the CE mark.
	This equipment meets the requirements of all relevant UK Statutory Instruments. The equipment carries the UKCA mark.
	This symbol, on the equipment, indicates that the user should read the user manual.
	This symbol, on the equipment, indicates a warning and that the user should refer to the user manual.
	This symbol warns the user of the danger of electric shock.
	This symbol warns the user of the danger of hot surfaces.
	<p>Druck is an active participant in the UK and EU Waste Electrical and Electronic Equipment (WEEE) take-back initiative (UK SI 2013/3113, EU directive 2012/19/EU).</p> <p>The equipment that you bought has required the extraction and use of natural resources for its production. It may contain hazardous substances that could impact health and the environment.</p> <p>In order to avoid the dissemination of those substances in our environment and to diminish the pressure on the natural resources, we encourage you to use the appropriate take-back systems. Those systems will reuse or recycle most of the materials of your end life equipment in a sound way. The crossed-out wheeled bin symbol invites you to use those systems.</p> <p>If you need more information on the collection, reuse, and recycling systems, please contact your local or regional waste administration.</p> <p>Please visit the link below for take-back instructions and more information about this initiative.</p>



<https://druck.com/weee>

Abbreviations

The following abbreviations are used in this manual; the abbreviations are the same in the singular and plural.

Abbreviation	Description
A	Ampere
ac	Alternating Current
cm	Centimetre
cSt	Centistokes
dc	Direct Current
DUT	Device Under Test
e.g.	For example
etc.	And so on
FS	Full Scale
h	Hour
i.e.	That is
lbs	Pounds
LED	Light Emitting Diode
m	Minute
max	Maximum
min	Minimum or minute
mm	Millimetre
n/a	Not Applicable
PC	Personal Computer
PID	Proportional Integral Differential
PV	Primary Variable
SP	Set Point
Ref	Reference
RH	Relative Humidity
SP	Set Point
T _R	Room Temperature
V	Volts
VA	Volt Ampere
°C	Degrees Celsius
°C/min	Degrees Celsius per minute
°F	Degrees Fahrenheit

Contents

1.	Description	1
1.1	Models	1
1.2	Unpacking	1
1.3	Intended Purpose	2
2.	Safety Instructions	2
2.1	Qualified Personnel	2
2.2	General Safety Instructions	3
2.3	Special Safety Instructions	3
2.4	Calibration Liquid Safety Instructions	3
2.4.1	Water	4
2.4.2	Silicone Oil	4
2.4.3	Mineral Oil	4
3.	Construction and Function	5
3.1	Construction	5
3.2	Function	6
3.2.1	Operation Procedure	6
4.	Commissioning and Operation	6
4.1	Operating Conditions	7
4.2	Electrical Connection	7
4.2.1	Electrical Connection Procedure	7
4.3	Calibrator Preparation	8
4.3.1	Adaptor Sleeve Insert	8
4.3.2	Infrared Insert	9
4.3.3	Micro Bath	10
4.4	Switching On, Cool Down and Switching Off	16
4.4.1	Switching On	17
4.4.2	Cooling Down the Calibrator	18
4.4.3	Switching Off	18
4.5	Operating Modes	18
5.	Operation	19
5.1	Controller Overview	19
5.2	Calibration Mode	20
5.2.1	Reference and Set Point Temperature Display	20
5.2.2	Display of Heating Control	20
5.2.3	Display of Fan / Cooling Control	21
5.2.4	Display of Heating / Cooling Capacity and Operating Duration	21
5.2.5	Configuration Menu	22
5.3	Temporary Set Point Mode	22
5.4	Main Menu	22
5.4.1	Automatic Control	23
5.4.2	Manual Control	25
5.4.3	Set Point Memory	27
5.4.4	Gradient Control / Temperature Profile	29

5.5	Remote Control	35
6.	Testing Process / Calibration	35
6.1	Testing Temperature Sensors	35
6.2	Testing Procedure	35
6.2.1	Before Starting	35
6.2.2	Performing the Testing	36
6.2.3	Canceling the Testing	36
6.2.4	After the Testing	36
7.	Troubleshooting	36
8.	Maintenance, Cleaning and Transportation	37
8.1	Maintenance	37
8.1.1	Before Use	37
8.1.2	Annually	37
8.1.3	Recalibration	37
8.1.4	Calibration Liquid	37
8.1.5	Magnetic Stirrer	38
8.1.6	Mains Fuses	38
8.2	Recalibration	38
8.3	Cleaning	38
8.3.1	Exterior Chassis	38
8.3.2	Vent Grilles for Inlet Air	39
8.3.3	Inserts	39
8.3.4	Micro Bath	39
8.4	Return Goods/Material Procedure	39
8.4.1	Safety Precautions	40
9.	Decommissioning and Disposal	40
9.1	Before Decommissioning	40
9.2	Decommissioning	40
9.3	Disposal of Calibration Liquid	40
9.4	Disposal of Calibrator	40
10.	Specification	41
10.1	Shared Specification	41
10.2	DryTC Specification	42
10.3	LiquidTC Specification	43
10.4	Heating and Cooling Times	44
10.4.1	DryTC165	44
10.4.2	DryTC650	45
10.4.3	LiquidTC165	45
10.4.4	LiquidTC255	46

1. Description

The DryTC / LiquidTC Series calibrators are used to test and calibrate temperature measuring instruments and temperature sensors, as well as for measuring temperatures. Typical applications include the test and calibration of thermometers, temperature switches/thermostats, resistance thermometers and thermocouples.

The portable instruments are of compact and robust construction so can be used on-site or in a laboratory.

The DryTC / LiquidTC Series may be used for service purposes, or industrial and laboratory applications.

1.1 Models



DryTC165



DryTC650



LiquidTC165



LiquidTC255

Model	Temperature Range	Function
DryTC165	-35°C to 165°C (-31°F to 329°F)	Dry Block
DryTC650	T _R to 650°C (T _R to 1202°F)	Dry Block
LiquidTC165	-35°C to 165°C (-31°F to 329°F)	Micro Bath
LiquidTC255	T _R to 255°C (T _R to 491°F)	Micro Bath

1.2 Unpacking



INFORMATION The temperature calibrators are delivered in special protective packaging. Save the packaging for returning the instrument safely to the manufacturer for calibration or repair.

- Carefully unpack the unit to prevent any damage.
- Check the completeness of the delivery based on the delivery note.

Table 1: Delivery Checklist

Item	DryTC165 DryTC650	LiquidTC165 LiquidTC255
Druck Temperature Calibrator	✓	✓
Mains cable.	✓	✓
Test certificate.	✓	✓

Table 1: Delivery Checklist

Item	DryTC165 DryTC650	LiquidTC165 LiquidTC255
Directions on how to download the instruction manual.	✓	✓
Protective packaging and transportation protection.	✓	✓
Insert exchange tool.	✓	
Transport cover.		✓
Work cover with five silicone plugs.		✓
Sensor cage.		✓
Magnetic stirrer.		✓
Magnetic lifter.		✓
Drain syringe.		✓

1.3 Intended Purpose

The DryTC and LiquidTC Series of calibrators may only be used for the testing and calibration of suitable temperature measuring instruments, temperature sensors and for measuring temperatures.

The calibrators may not be used for warming up or heating materials or gases. The calibrators have been designed for indoor use only.

The micro baths may only be used with a suitable calibration liquid. Permitted liquids are silicone oils, mineral oils and water. See Section 2.4.

Hazardous media (flammable or explosive liquids or gases) may not be used.

The operational safety of the calibrator is only guaranteed by intended use. The specified limits may under no circumstances be exceeded. See Section 10.

It is your responsibility to select the instrument, which is suitable for your specific application, to connect it correctly, to carry out the tests safely and to maintain all components.

2. Safety Instructions

Before you use the calibrator, read through this operating manual carefully. If the instructions are not followed, in particular the safety guidelines, this could result in danger for people, the environment, and the calibrator and the system it is connected to.

The calibrator represents state-of-the-art technology. This encompasses accuracy, operating function and the safe operation of the calibrator.

In order to guarantee that the calibrator operates safely, the operator must act competently and be conscious of safety issues.

Druck provides support for the use of its products either personally or via relevant literature. The customer verifies that our product is fit for purpose based on our technical information. The customer performs customer-specific and application-specific tests to ensure that the product is suitable for the intended use. With this verification, all hazards and risks are transferred to our customers; our warranty is not valid.

2.1 Qualified Personnel

- The personnel in charge of the installation, operation and maintenance of the calibrator must hold a relevant qualification. This can be based on training or relevant instructions.
- Personnel must be aware of this operating manual and have access to it at all times.

2.2 General Safety Instructions

- In all work, the existing national regulations for accident prevention and safety in the workplace must be complied with. Any internal regulations of the operator must also be complied with, even if these are not mentioned in this manual.
- Ensure that the complete operating instructions are always available at the calibrator installation site.
- Degree of protection according to EN 60529. Ensure that the ambient conditions at the site of use does not exceed the requirements for the stated protection rating, see Section 10.1.
- Structural safety in accordance with EN 61010-1. The calibrator must be installed in such a way that the requirements for structural safety are met.
- Only use the calibrator if it is in perfect condition. Damaged or faulty calibrators must be checked without delay and, if necessary, replaced.
- If problems cannot be remedied, immediately shut down the calibrator and ensure that it cannot be started up accidentally.
- Never leave the calibrator unattended when it is in operation or in the cooling phase.
- Do not remove or destroy type plates or other markings on the calibrator, or the warranty is rendered null and void.

2.3 Special Safety Instructions



INFORMATION The transport cover has a pressure relief safety valve. The valve opens when the micro bath pressures exceeds ~1.5 bar. This can result in hot vapor being released.

Remove the transport cover before using the micro bath.

Wait until the micro bath has cooled down before screwing on the transport cover.

- Thermal protection fuse.
 - a. The calibrator is equipped with a thermal protection fuse that works independently. If there is an over-temperature inside the housing, the power supply to the heating system is cut off. The thermal protection fuse is non-resettable. The calibrator cannot be used anymore.
 - b. After the calibrator has cooled, return the calibrator to Druck.
- Risk of injury from hazardous gases.
 - a. When liquids are heated, evaporation can result in dangerous gases being released.
- The calibrator may not be used in a potentially explosive atmosphere.
 - a. Remove all the easily flammable media from the vicinity of the calibrator.
 - b. Ensure that the calibrator cannot come in contact with easily flammable or explosive media.
- Operate the calibrator only in the temperature range permissible for the DUT.
- Ensure that the DUT is held securely in the calibrator.
 - a. Use only suitable inserts.
 - b. When doing so, also ensure that the structural safety of the calibrator is retained.

2.4 Calibration Liquid Safety Instructions

Before using calibration liquids, read the entire safety data sheet thoroughly. Pay particular attention to the information on the physical and chemical properties.

Only use calibration liquids that are suitable for the required temperature range, and which are not flammable.

Druck recommends the following calibration liquids:

Table 2: Calibration Liquids

Calibration Liquid	Calibration Range	Flashpoint
Distilled Water	2 °C to 95 °C (35.6 °F to 203 °F)	none
XIAMETER™ PMX-200 Silicone Fluid 5 cSt	-40 °C to 123 °C (-40 °F to 253.4 °F)	133 °C (271.4 °F)
XIAMETER™ PMX-200 Silicone Fluid 10 cSt	-35 °C to 155 °C (-31 °F to 311 °F)	165 °C (149 °F)
XIAMETER™ PMX-200 Silicone Fluid 20 cSt	7 °C to 220 °C (44.6 °F to 428 °F)	230 °C (446 °F)
XIAMETER™ PMX-200 Silicone Fluid 50 cSt	50 °C to 270 °C (122 °F to 518 °F)	280 °C (536 °F)

2.4.1 Water

- Only use distilled water, otherwise excessive limescale and soiling will build up in the calibrator micro bath tank.

2.4.2 Silicone Oil

- Use only the silicone oil recommended in Table 2.
- Always read the safety data sheet supplied with the silicone oil before using it.
- Always ensure adequate ventilation when working with silicone oil, since hazardous substances can be released.
- Prevent silicone oil from coming into contact with your eyes.
- Since silicone oil is hygroscopic, always use the transport cover to close the calibration bath after use.

2.4.3 Mineral Oil

- Druck supplies silicone oil with the calibrators.
- Using mineral oil is possible, but must be done at your own risk. The danger and the risk must be borne by the user and our warranty will be rendered null and void.
- Please follow the safety data sheet of the mineral oil used.
- The safety instructions for silicone oil apply equally to mineral oils as well. The same also applies to the corresponding sections for silicone oil in this operating manual.

3. Construction and Function

3.1 Construction

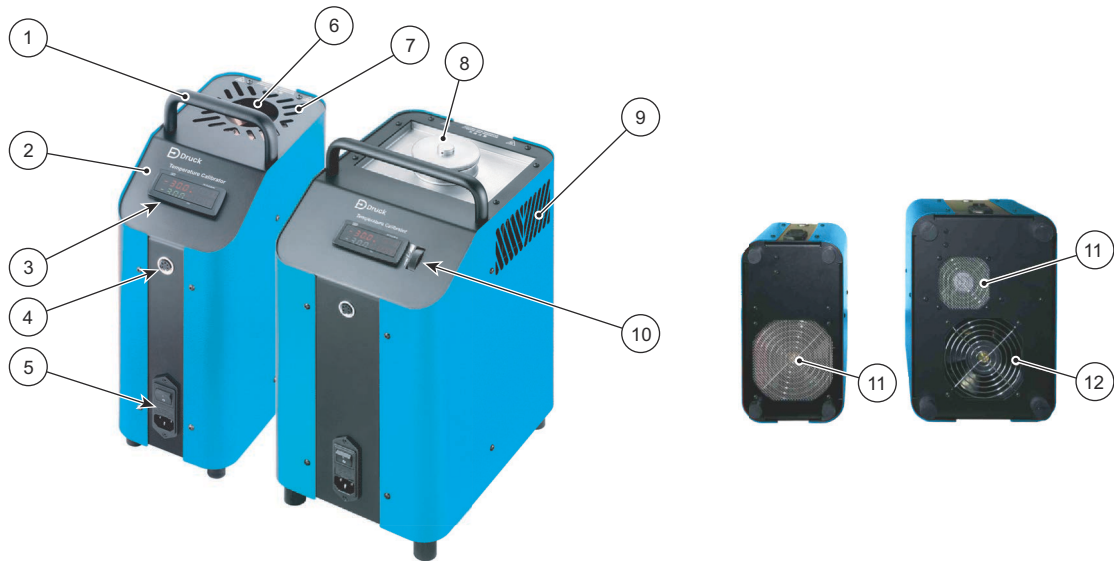

- 1 Carrying handle.
- 2 Steel housing.
- 3 Controller display and keypad.
- 4 Service and data interface.
- 5 Mains inlet, switch with fuses.
- 6 Dry block.
- 7 Exhaust cooling air through upper housing grilles.
- 8 Micro bath with transportation cover.
- 9 Exhaust cooling air through side housing grilles.
- 10 Magnetic stirrer speed control. (LiquidTC only)
- 11 Inlet air for housing cooling.
- 12 Inlet air for dry block / micro bath cooling.

Figure 1: General View

The calibrator consists of a robust steel housing (2) with integral carrying handle (1). The display (3) is located on the front panel of the unit. LiquidTC calibrators have a thumb wheel (10) to control the speed of the magnetic stirrer.

The mains inlet, switch and fuses (5) are located on the front of the unit. The service and data interface (4) is located underneath the display (3).

During operation, cooling air is drawn in from the base of the unit (11, 12) and expelled through grilles (7, 9). DryTC calibrators expel air through the top of the unit (7). LiquidTC calibrators expel air through side grilles (9).

The rear section of the housing contains the insulated dry block or micro bath. Heating elements, together with an integrated temperature sensor, are used to regulate the temperature of the dry block / micro bath. Some models contain cooling elements. These allow the temperature to be regulated below room temperature.

3.2 Function

The function of the calibrator is determined by the calibrator model and the installed insert. Figure 2 shows an overview of the available inserts. Table 3 shows the compatibility of insert, calibrator model and function.

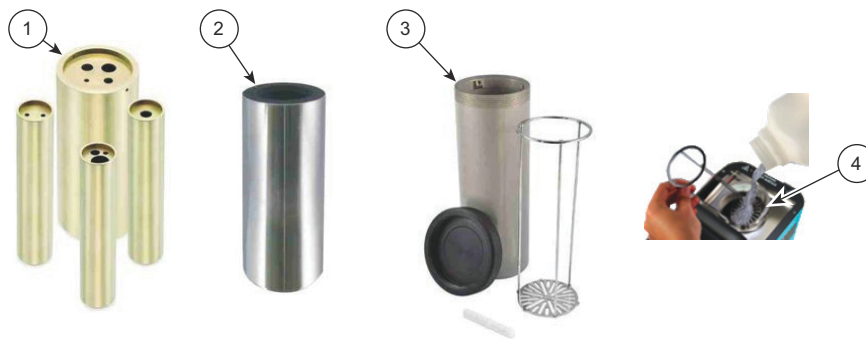

Figure 2: Insert Overview

Table 3: Insert Compatibility

Ref	Insert	Function	DryTC165 DryTC650	LiquidTC165 LiquidTC255
1	Adaptor Sleeve	Dry Block	✓	✓
2	Infrared	Infrared		✓
3	Tub	Micro Bath		✓
4	Micro Bath (Direct Filling) ^a	Micro Bath		✓

a. Direct filling of the micro bath with calibration liquid, LiquidTC models only.

3.2.1 Operation Procedure

1. Install a suitable insert into the calibrator, see Section 4.3. Ensure that the insert has a secure fit to ensure optimum heat transfer to the DUT.
2. Once all preparations have been completed, switch on the calibrator. See Section 4.4.1.
3. The calibrator heats or cools the dry block, or calibration liquid, to the set point temperature. As soon as the temperature is stable, the DUT can be calibrated.
4. Repeat step 3 for all the required calibration set points.

4. Commissioning and Operation



WARNING The calibrator may become very hot during operation. If the calibrator is operated without supervision, third-party persons in the vicinity could get injured. Moreover, flammable material could come into contact with the calibrator and cause significant harm to personnel and/or damage to property.

Never leave the calibrator unattended when it is in operation or in the cooling down phase.

For safe operation of the calibrators, a formal commissioning procedure is necessary.

Commissioning includes the installation, electrical connections, preparation for the calibration as well as correct switching on and off of the calibrator.

Further, a visual inspection for damage is required before use.

The required steps are described in the following sections.

4.1 Operating Conditions



INFORMATION The plug of the mains connecting cable serves as a emergency stop device. Ensure that the plug is always easily accessible and easy to reach. In an emergency, pull the plug so that the calibrator is isolated from the mains.

Select a safe installation site for commissioning the calibrator.

Considerations for selecting a safe installation site and calibrator operating position:

- Only suitable for indoor use, do not use outdoors.
- Operate only in the vertical position on an even surface. The surface must be stable, clean, and dry.
- If the operational conditions do not conform to the above, the structural safety and the specified properties of the calibrator cannot be guaranteed.
- At high testing temperatures, it is recommended to use a sufficiently large, fire-resistant, supporting surface.
- Ensure sufficient clearance around the calibrator. On the front side > 1 m, behind and to the sides > 0.5 m. Ensure that there is sufficient head clearance and sufficient clear space above the calibrator.
- Ensure sufficient ventilation.
- Do not operate in the vicinity of flammable materials.
- Do not install in a cupboard or other similar confining location.
- The ventilation openings must not be blocked or covered.
- The calibrator must be installed so that it can be switched off at any time.

4.2 Electrical Connection



RISK OF ELECTRIC SHOCK Calibrators that have been exposed to high humidity for long periods have an initial higher than normal earth leakage current. Ensure that the calibrator is always connected to a protective earth.

Always use a known good mains cable with an appropriate power plug.

Use only a Druck specified mains cable.

Ensure that the mains outlet is adequately rated and has a protective earth connection.

Before turning on the power, make sure that the calibrator is properly connected to the protective earth. The protective earth is connected to the calibrator through the mains plug.

Check the following points before you connect the calibrator:

1. Check the specified operating mains supply voltage range for the calibrator. See Section 10.
2. Ensure that the mains voltage range is the same as that specified on the rating plate.
3. Only connect the calibrator to a properly installed and earthed 3-pole socket for mains plugs with earthing contact.
4. Only use extension cables or adaptor plugs with a protective earth connection.

4.2.1 Electrical Connection Procedure

1. Insert the mains cable into the mains inlet socket of the calibrator.
2. Insert the plug of the mains cable in a suitable mains outlet with earthing contact.

4.3 Calibrator Preparation



HOT SURFACE The calibrator may become very hot when in operation. Touching hot parts can result in serious injuries.

Never touch the dry block, micro bath, inserts or the DUT at temperatures above 35 °C (95 °F) or below 10 °C (50 °F).

Allow the calibrator to cool before you remove the DUT, change the insert or switch off the calibrator.



INFORMATION Empty and clean the micro bath tank after usage (LiquidTC models only). Otherwise inserts may become stuck in the calibrator.

The preparations for the micro bath must be carried out with the calibrator switched off and cooled to room temperature.

The function of the calibrator is determined by the installed insert. The required insert is installed into the opening of the dry block or micro bath. By using inserts, it is easy to switch between dry block, infrared and micro bath functions.

For an overview of insert compatibility, see Section 3.2 on page 6.

4.3.1 Adaptor Sleeve Insert

Adaptor sleeves with single or multiple holes are used for the calibration of straight temperature sensors. For adaptor sleeve insert compatibility, see Section 3.2 on page 6.

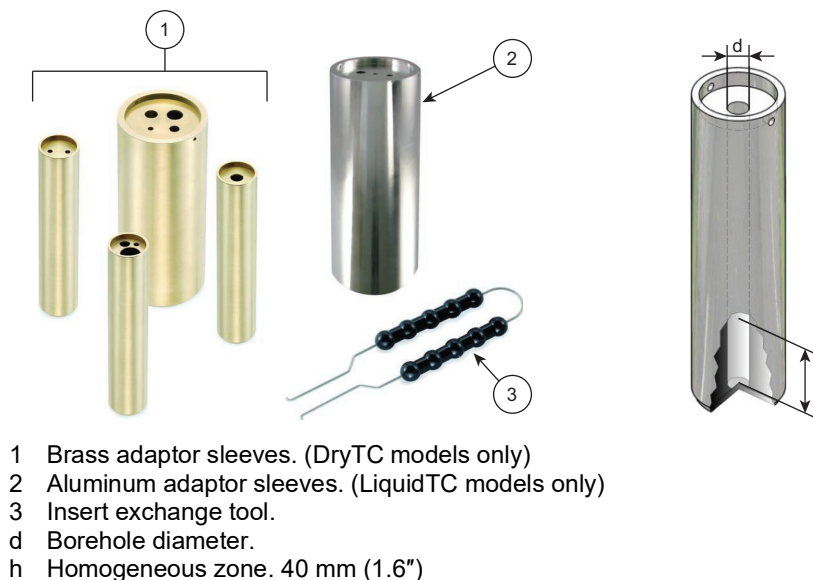

Figure 3: Adaptor Sleeve Inserts

To achieve the specified accuracy of the calibrator, the DUT and the adaptor sleeve must be matched to one another:

1. The borehole of the adaptor sleeve must be no greater than 0.5 mm of the DUT diameter.
2. The measurement element of the DUT must be located in the homogeneous temperature zone of the adaptor sleeve. See Figure 3, dimension h.

4.3.1.1 Installation



INFORMATION Use only Druck adaptor sleeves.
If in doubt, contact Druck.

The adaptor sleeve is inserted into the dry block using the insert exchange tool, see Figure 3 item 3.

4.3.1.2 Removal and Cleaning

1. Allow the calibrator cool before the adaptor sleeve is removed.
2. Pull the adaptor sleeve out of the dry block with the help of the insert exchange tool, see Figure 3 item 3.
3. Clean the adaptor sleeve and the dry block to prevent inserts from getting stuck in the dry block.

4.3.2 Infrared Insert

The infrared insert is used for contact-less measurement infrared thermometers. The infrared insert has a specially designed surface and surface coating on the inside. As a result, an emissivity of 0.9994 (black body) is achieved.

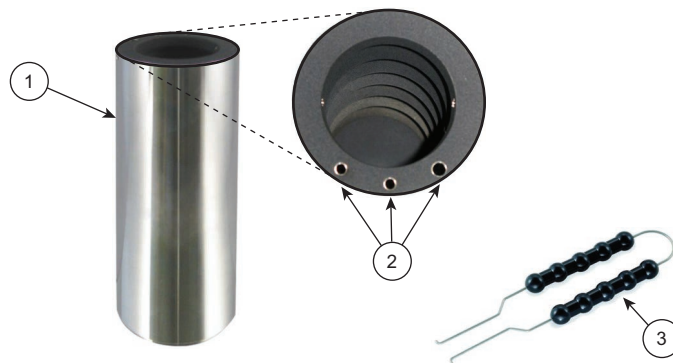

- 1 Infrared insert.
- 2 External sensor bore holes:
2 × 3.5 mm (0.138")
1 × 4.5 mm (0.177")
- 3 Insert exchange tool.

Figure 4: Infrared Insert

The additional holes in the border, see Figure 4 item 2, are for external reference sensors. This allows the exact temperature of the inside face of the infrared insert to be determined.

4.3.2.1 Installation

1. The infrared insert is inserted into the dry block using the insert exchange tool, see Figure 4 item 3.
2. Centre the infrared insert so that there is an even air gap between the infrared insert and the dry block.

4.3.2.2 Removal and Cleaning

1. Allow the calibrator cool before the infrared insert is removed.
2. Pull the infrared insert out of the dry block with the help of the insert exchange tool, see Figure 4 item 3.
3. Clean the infrared insert and the dry block to prevent inserts from getting stuck in the dry block.

4.3.2.3 Application Tips

1. The measuring spot of the infrared thermometer must project itself onto the floor of the infrared insert during the calibration. The measuring spot must be smaller than the inner diameter and must not touch the wall of the infrared insert.
2. Ice or condensation can form in the infrared insert at temperatures of less than 0 °C (32 °F) in high humidity levels. This can affect the emissivity of the infrared insert and degrade the calibration accuracy. Ice or condensation formation can be reduced by:
 - a. Covering the measuring opening of the infrared insert.
 - b. Keeping the measuring opening closed for as long as possible.
 - c. Only opening the measuring opening briefly for the calibration.

Note: Ice or condensation can be removed by gently heating the infrared insert.

4.3.3 Micro Bath



WARNING Wear safety goggles. Calibration liquid may be ejected when working with the micro bath. Always wear safety goggles when handling calibration liquids.

The micro bath is used for calibrating sensors with special shapes or dimensions. Direct contact between the sensor and the calibration liquid ensures excellent heat transfer.

The calibration liquid is poured directly into the micro bath tank / tub insert.

The micro bath includes the following accessories:

- Transport Cover
- Work Cover
- Sensor Cage
- Magnetic Stirrer
- Drain Syringe
- Magnetic Lifter

Note: A removable tub insert is available as an optional accessory.

The accessories are described in more detail in the following sections.

4.3.3.1 Transport Cover



WARNING Remove the transport cover before using the micro bath.

The transport cover has a pressure relief safety valve. The valve opens when the micro bath pressures exceeds ~1.5 bar. This can result in hot vapor being released.

The transport cover seals the micro bath, preventing spillage of the calibration liquid during transportation.



Figure 5: Transport Cover

4.3.3.2 Work Cover



Figure 6: Work Cover

The work cover is used to:

- Reduce evaporation of the calibration liquid.
- Reduce the cooling of the surface of the calibration liquid.
- Provide stable positioning of the DUT in the micro bath.

The work cover is screwed on to the micro bath and has five openings for DUT. The unused openings can be closed with the suitable silicone plugs.

4.3.3.3 Sensor Cage and Magnetic Stirrer

The sensor cage protects the magnetic stirrer. It prevents the DUT from stopping the magnetic stirrer from rotating.

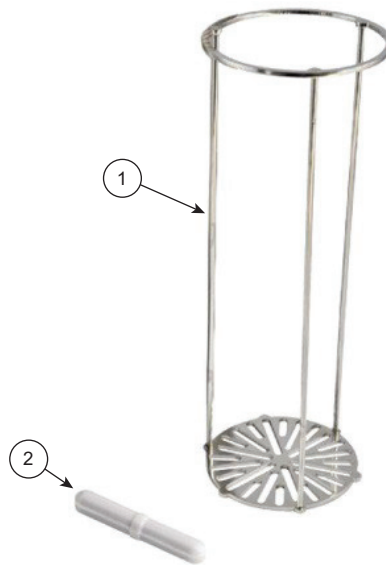

- 1 Sensor cage.
- 2 Magnetic stirrer.

Figure 7: Sensor Cage and Magnetic Stirrer

The magnetic stirrer ensures a uniform temperature distribution in the calibration liquid. Use the thumb wheel, see Figure 1 item 10, to control the speed of the magnetic stirrer.

Note: The magnetic stirrer is subject to mechanical wear and tear during normal operation. The magnetic stirrer has a limited lifetime and requires periodic replacement. See Section 8.1.

4.3.3.4 Drain Syringe and Magnetic Lifter

The drain syringe is used to pump out the calibration liquid from the micro bath. The magnetic stirrer is removed with the help of the magnetic lifter.



Figure 8: Magnetic Lifter

Note: The micro bath must be drained of calibration liquid and the magnetic stirrer removed before another insert is inserted into the calibrator.

4.3.3.5 Tub Insert (Optional Accessory)

The tub insert is a removable calibration liquid container. It is designed to be inserted and used in the micro bath tank of the calibrator.



Figure 9: Tub Insert

A tub insert is highly recommended if workload involves:

- a. Frequent changes between dry block, infrared and micro bath function.
- b. Frequent changes between different calibration liquids.

The tub insert is inserted into the micro bath using the insert exchange tool, see Figure 9 item 3. The tub insert is supplied with a transport cover to prevent spillage of the calibration liquid during transportation.

4.3.3.6 Notes on Calibration Liquid



WARNING Wear safety goggles. Calibration liquid may be ejected when working with the micro bath. Always wear safety goggles when handling calibration liquids.

Different calibration liquids give different calibration results due to their specific characteristics. Adjustment to the respective calibration liquid has to be carried out by the manufacturer.

In order to achieve the best possible accuracy of a micro bath, it has to be filled with a suitable calibration liquid. The calibration liquid is poured directly into the micro bath tank / tub insert.

Note: It is recommended to use silicone oil as the calibration liquid.

1. When using water as the calibration liquid:
 - Only use distilled water, otherwise excessive limescale and soiling will build up in the tank.
2. When using silicone oil as the calibration liquid:
 - Always read the safety data sheet supplied with the silicone oil before use.
 - Always ensure adequate ventilation when working with silicone oil. Hazardous substances may be released.
 - Spilled or leaked silicone oil results in an extreme danger of slipping. Always clean up spills.
 - Silicone oil is hygroscopic. Use the transport cover to seal the micro bath, or tub insert, after use.

4.3.3.7 Notes on Cleanliness



INFORMATION Only use clean calibration liquid.

The verification and calibration of DUT can lead to a contamination of the calibration liquid. Contamination can lead to smeary gel effect on the bottom of the tank due to the rotation of the magnetic stirrer. This can effect the calibration accuracy.

It is highly recommended to:

1. Clean the micro bath tank / tub insert.
2. Clean the DUT before calibration.
3. Replace worn magnet stirrers.
4. Replace contaminated calibration liquid.

4.3.3.8 Notes on Calibration Liquid Fill Level



PREVENT FAILURE Do not exceed the maximum fill level during operation. Overflow of calibration liquid causes contamination and may cause damage to the calibrator.



INFORMATION Incorrect calibration liquid fill level results in inaccurate calibration. Filling above the maximum fill level leads to excessive heat dissipation, preventing compliance with specified tolerances.

The fill level in the micro bath or tub insert rises as a result of:

- a. Thermal Expansion – Calibration liquids expand to varying degrees as a result of heating. The increase in fill level depends on the calibration liquid in use and the applied temperature.
- b. Displacement by Sensors – The volume displaced by DUT must be taken into account in determining the filling amount.
- c. Rise due to Stirring – The rotation of the magnetic stirrer forms a whirlpool in the liquid. This raises the fill level at the wall.

The maximum fill levels are shown below:

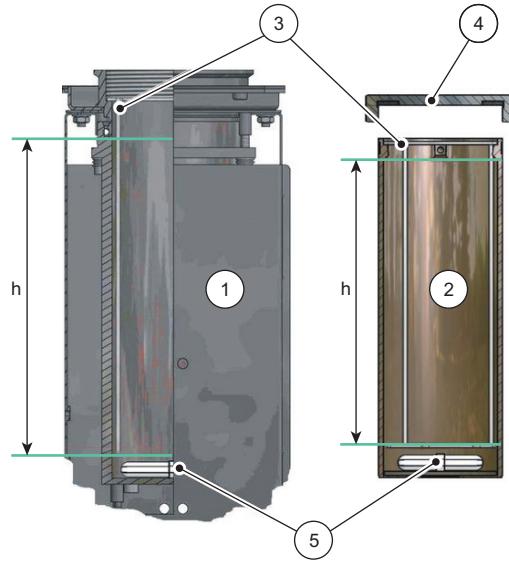

- 1 Micro bath tank.
- 2 Tub insert.
- 3 Sensor cage.
- 4 Tub insert transport cover.
- 5 Magnetic stirrer.

Figure 10: Maximum Fill Level

	Micro Bath Tank	Tub Insert
Maximum Fill Level (h)	150 mm (5.91")	136 mm (5.35")
Maximum Fill Volume	~0.45 litres (15.22 fl oz)	~0.32 litres (10.82 fl oz)

Note: The maximum fill level line for the micro bath tank is located next to the upper edge of the aluminum lining. The maximum fill level line for the tub insert is below the sleeve exchange tool fixture.

4.3.3.9 Filling with Calibration Liquid



INFORMATION Pay attention to maximum calibration liquid filling level, see Section 4.3.3.8.

When filling, leave enough room for thermal expansion, displacement by the DUT and level rise due to stirring.



Figure 11: Filling with Calibration Liquid

Micro bath filling procedure:

1. Unscrew the transport cover of the micro bath.

2. Place the magnetic stirrer into the micro bath.
3. Insert the sensor cage.
4. Insert the DUT into the sensor cage, before filling, to account for its volume.
5. Fill the micro bath with calibration liquid.

Note: Observe the maximum fill level and leave sufficient reserve space for an additional rise in the level.

6. If necessary, remove the DUT.
7. Screw the work cover into place.
8. Insert the DUT through the work cover into the micro bath.

Tub insert filling procedure:

1. Unscrew the transport cover of the tub insert.
2. Insert the tub insert into the micro bath tank using the sleeve exchange tool.
3. Place the magnetic stirrer into the tub insert.
4. Insert the sensor cage.
5. Insert the DUT into the sensor cage, before filling, to account for its volume.

6. Fill the tub insert with calibration liquid.

Note: Observe the maximum fill level and leave sufficient reserve space for an additional rise in the level.

7. If necessary, remove the DUT.
8. Screw the work cover into place.
9. Insert the DUT through the work cover into the tub insert.

4.4 Switching On, Cool Down and Switching Off

For reasons of safety, when switching on the calibrator, the fan runs at the fastest speed. As soon as the internal reference sensor has measured a safe temperature, the fan speed is adjusted accordingly.

4.4.1 Switching On



WARNING The calibrator must be securely connected to protective earth, otherwise there is a danger to life from electric shock.

Before turning on the power, make sure that the earth connection of the calibrator is properly connected to the protective earth.



WARNING After transport, storage or long periods of non-use, moisture can seep into the heating elements (magnesium oxide).

To dry the heating elements, the calibrator must be slowly warmed up. During this process, the calibrator has not yet reached the required electrical insulation for protection class I.

To dry the heating elements, set the calibrator to 120 °C (248 °C) for at least 15 minutes.



INFORMATION Do not expose the calibrator to high levels of humidity for a long time. Excessive condensation can occur on the calibrator if a cold unit is brought into a considerably warmer place.

Before switching on the calibrator, allow it to acclimatise for at least 2 hours at room temperature.

1. Turn on the mains switch.
2. The controller is initialized.

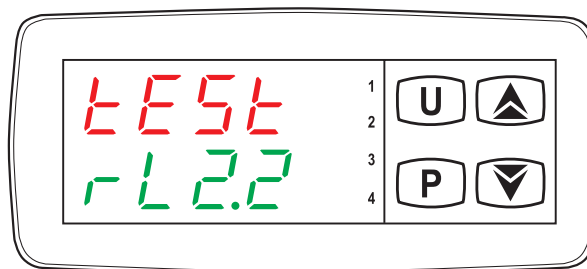

Figure 12: Controller Initialization

- a. *tEST* appears in the upper display.
 - b. The controller software version appears on the lower display.
3. Initialization is completed after approximately 5 seconds.
 4. The controller enters into calibration mode, see Section 5.2.
 5. The controller automatically adjusts the calibrator from room temperature to the required set point temperature.

4.4.2 Cooling Down the Calibrator



HOT SURFACE The calibrator may become very hot when in operation. Touching hot parts can result in serious injuries.

Never touch the dry block, micro bath, inserts or the DUT at temperatures above 35 °C (95 °F) or below 10 °C (50 °F).

Allow the calibrator to cool before you remove the DUT, change the insert or switch off the calibrator.



INFORMATION In the event of mains failure, or if the mains switch is turned off, or if the mains plug is removed due to an emergency stop, the built-in fan stops and does not provide cooling. Sufficient thermal decoupling between the micro bath / dry block and the housing is nonetheless guaranteed.

In order to cool down the calibrator quickly, set the set point temperature to a low temperature, e.g. room temperature.

For calibrators with only heating elements. During cooling, the built-in fan automatically runs at a higher speed. The LED OUT 2 indicates the status of the cooling fan control. If LED OUT 2 is lit, the fan is running at high speed. If LED OUT 2 is not lit, the fan is running at low speed.

For calibrators which can cool below room temperature. LED OUT 2 indicates the status of the active cooling. If LED OUT 2 is lit, the active cooling is running. If the LED OUT 2 is not lit, the active cooling is off.

4.4.3 Switching Off



INFORMATION Only switch off the calibrator when the dry block / micro bath has reached room temperature.

When switching off at high temperatures, the calibrator and/or the DUT may be damaged.

1. Check whether the dry block / micro bath has cooled down to room temperature.
2. Switch off the calibrator via the mains switch.
3. Disconnect the calibrator from mains power if no further testing is required.
4. Unplug the power cord from the wall outlet.
5. Clean the calibrator after use, see Section 8.3.

4.5 Operating Modes

The calibrator has three operating modes:

Table 4: Operating Modes

Operating Mode	Description
Calibration Mode	This is the normal operating mode in which the calibration of DUT is carried out. See Section 5.2
Set Point Mode	Temporary set point temperatures can be entered in this mode. See Section 5.3.
Main Menu	All settings can be modified in this mode, e.g. pre-setting the set point temperatures or setting the control parameters. See Section 5.4.

5. Operation

The calibrator is operated using the controller. LiquidTC calibrators have an additional thumb wheel to control the speed of the magnetic stirrer.

The controller is equipped with two 4-digit LED displays. One for the reference temperature and one for the set point temperature. The controller also contains discrete LED indicators and a keypad.

5.1 Controller Overview

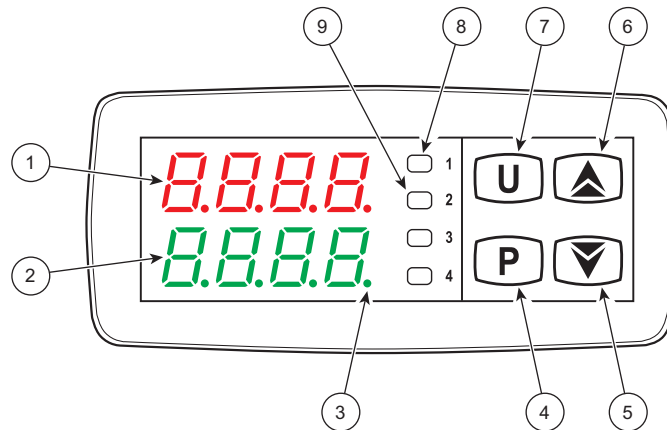

Figure 13: Controller Overview

1. Upper Display (Red)
 - Display of current reference temperature.
 - Display of individual modes, menu items and parameter.
2. Lower Display (Green)
 - Display of set point temperature.
 - Display of heating / cooling capacity.
 - Display of operating duration.
 - Display of certain parameters in individual modes and menu items.
3. LED SET – When flashing, it indicates access to individual menu items and parameters.
4. **P** key
 - Switching to set point mode.
 - Access to menu items and parameters.
 - Input confirmation.
5. **▼** key
 - Reducing values to be set.
 - Selection of individual menu items.
 - Return to previous menu level.
6. **▲** key
 - Increasing values to be set.
 - Display of current heating capacity in percentage.
 - Selection of individual menu items.
 - Return to previous menu level.

7. **U** key – Retrieves saved set point temperatures.
8. LED OUT 1 – Indicates the status of the output for the temperature control:
 - If LED OUT 1 is lit, the dry block or micro bath is heating.
 - If LED OUT 1 is not lit, the dry block or micro bath is not heating.
9. LED OUT 2
 - a. Heating Instrument – Indicates the status of the output for the fan control:
 - If LED OUT 2 is lit, the fan is running at high speed.
 - If LED OUT 2 is not lit, the fan is running at low speed.
 - b. Heating and Cooling Instrument – Indicates the status of the output for the temperature control:
 - If LED OUT 2 is lit, the dry block or micro bath is cooling.
 - If LED OUT 2 is not lit, the dry block or micro bath is not cooling.

5.2 Calibration Mode

The calibrator enters into calibration mode by default after being switched on.

5.2.1 Reference and Set Point Temperature Display

The upper (red) display is the current reference temperature of the dry block / micro bath. The lower (green) the display shows the current set point temperature.

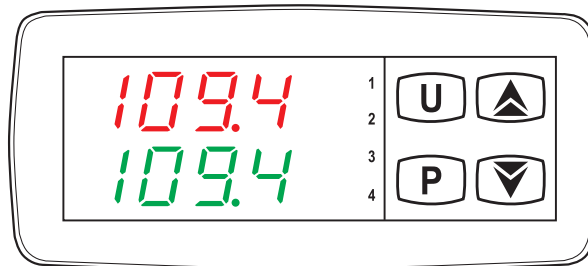

Figure 14: Reference and Set Point Temperature Display

There are two ways to set the set point temperature:

- a. Temporary set point temperature, see Section 5.3.
- b. Retrieving a saved set point temperature from the main menu, see Section 5.4.

5.2.2 Display of Heating Control

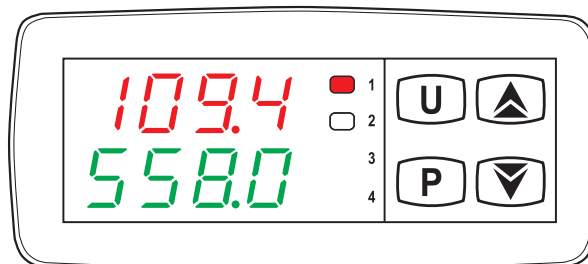

Figure 15: Active Heating Display

LED OUT 1 indicates the status of the heating control:

- If LED OUT 1 is lit, the heating element is switched on.
- If LED OUT 1 is not lit, the heating element is switched off.

If LED OUT 1 lights up permanently, the calibrator is heating up. The temperature control is active. The heating is being applied at full power so that the set point is reached as quickly as possible.

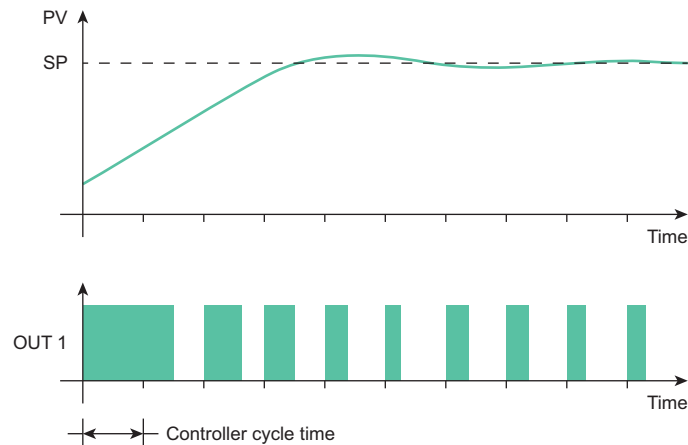

Figure 16: Regulation to Set Point Example

As the dry block / micro bath temperature nears the set point temperature, power is reduced to the heating element. This is to reduce overshoot. Power is controlled by pulse width modulation. LED OUT 1 begins to flash as power is reduced. The controller will automatically adjust the heating element power to maintain a stable temperature at the desired set point.

5.2.3 Display of Fan / Cooling Control

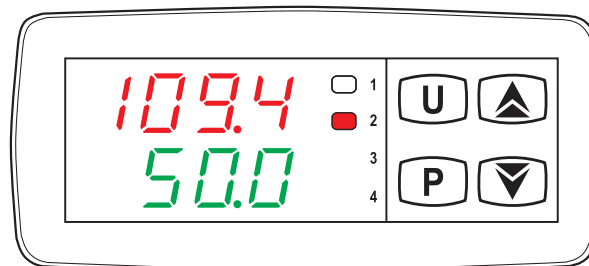

Figure 17: Active Fan / Cooling Display

LED OUT 2 indicates the status of the fan / cooling control:

- a. Heating Instrument – Indicates the status of the output for the fan control:
 - If LED OUT 2 is lit, the fan is running at high speed.
 - If LED OUT 2 is not lit, the fan is running at low speed.
- b. Heating and Cooling Instrument – Indicates the status of the output for the temperature control:
 - If LED OUT 2 is lit, the dry block or micro bath is cooling.
 - If LED OUT 2 is not lit, the dry block or micro bath is not cooling.

5.2.4 Display of Heating / Cooling Capacity and Operating Duration

In calibration mode, the heating or cooling capacity and the operating duration of the calibrator can be shown. The current values appear on the lower (green) display.

5.2.4.1 Heating / Cooling Capacity

1. Hold down the  key.
2. The current heating and cooling capacity is displayed in percentage of the maximum capacity.

- a. H indicates the heating capacity.
- b. C indicates the cooling capacity.

5.2.4.2 Operating Duration

1. Briefly press the  key.
2. The current number of operating hours of the calibrator is displayed for approximately 5 s.

5.2.5 Configuration Menu



INFORMATION The $CONF$ (configuration) menu is protected by a password.

Unauthorized access can damage the calibrator.

Exit the menu by pressing the  key twice.

The configuration menu contains important system parameters. These parameters shall only be modified by an authorized Druck service centre.

5.3 Temporary Set Point Mode

In this operating mode, it is possible to temporarily modify a saved set point temperature.

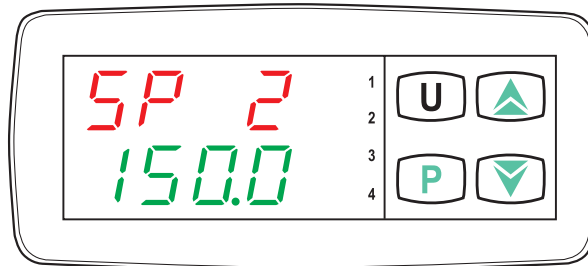







Figure 18: Temporary Set Point Mode



1. Press the  key briefly.
 - a. The current active set point, e.g. $SP\ 2$ (set point 2), is displayed on the upper display.
 - b. The respective set point temperature is displayed by the lower display.
2. Press the  key to increase the set point temperature.
3. Press the  key to decrease the set point temperature.
4. Press the  key again to confirm the new set point.

Note: Press the  and  key to raise and lower the value by 0.1 respectively. If the keys are held pressed for at least one second, the value increases or decreases quickly and after two seconds even more quickly; this means the desired value can be reached rapidly.

Note: If no key is pressed for approximately 15 seconds, the controller automatically returns to the calibration mode.

5.4 Main Menu

All settings can be found in the main menu.

1. Press the  key for approximately 5 seconds. The main menu opens.
2. Use the  and  keys to select the desired main menu, see Figure 19.

3. Press the **P** key to confirm the selected menu item.

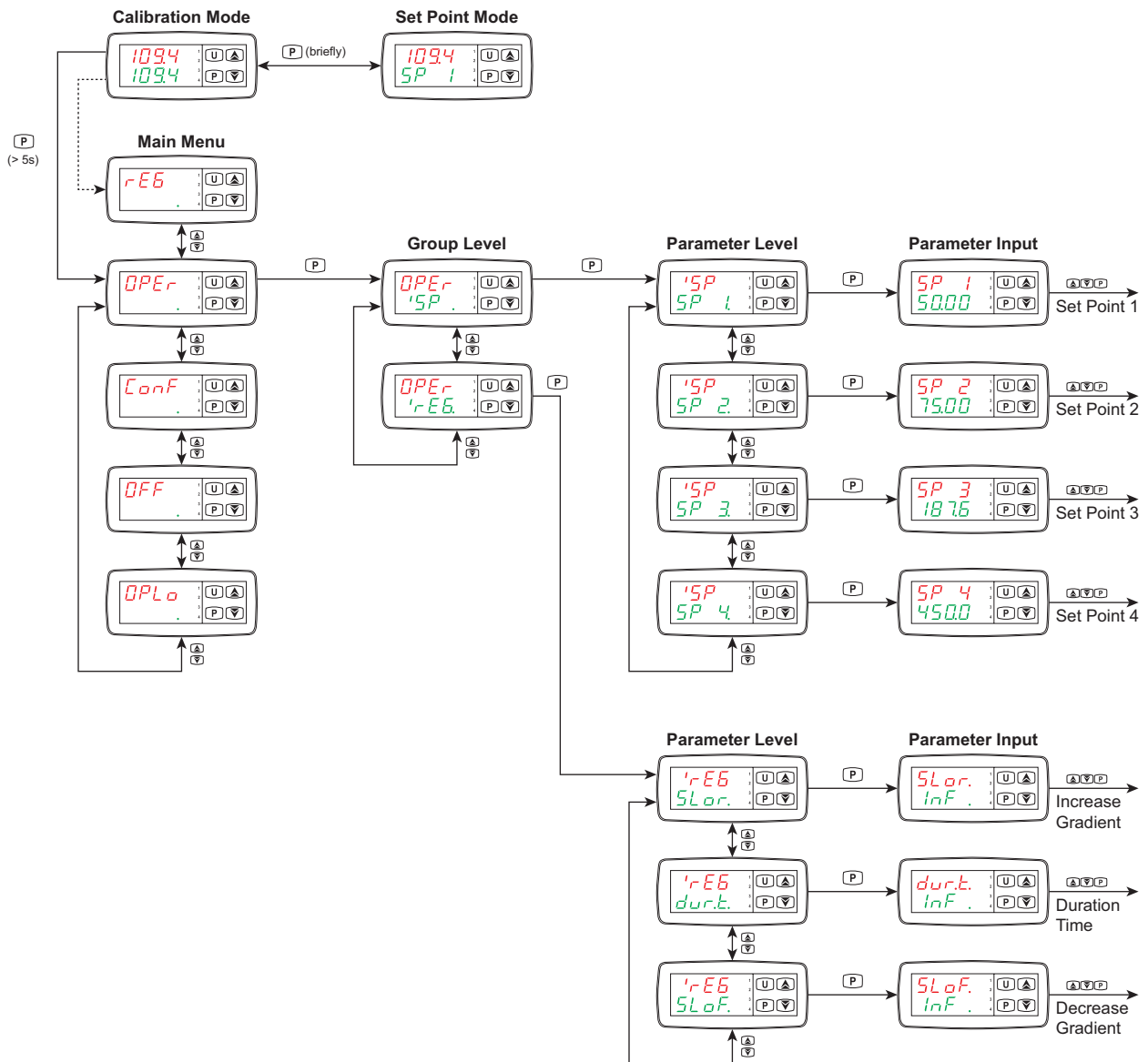

Figure 19: Main Menu Overview

As shown in the menu structure, it is possible to reach the group level and parameter levels to change settings via the **OPER** menu.

Note: If no key is pressed for approximately 15 seconds, the controller automatically returns to calibration mode.

Menu levels can be navigated by pressing and holding the **▼** or **▲** key.

5.4.1 Automatic Control

For certain tasks it can be advantageous to switch off the automatic control, e.g. to change the calibrator's settings.

5.4.1.1 Switching Off Automatic Control

1. Press the **P** key when in calibration mode for approximately 5 seconds. The main menu opens.

The last selected function appears on the upper display.
LED SET flashes on the lower display.

2. Press the  or  key until *OFF* appears.

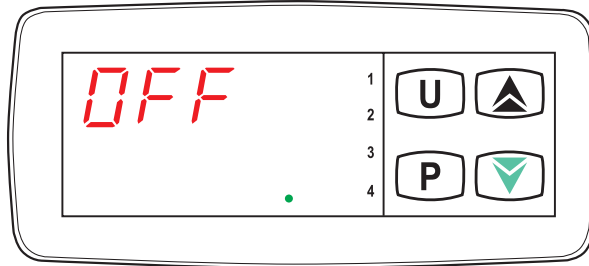

Figure 20: Control OFF Menu

3. Press the  key to confirm.

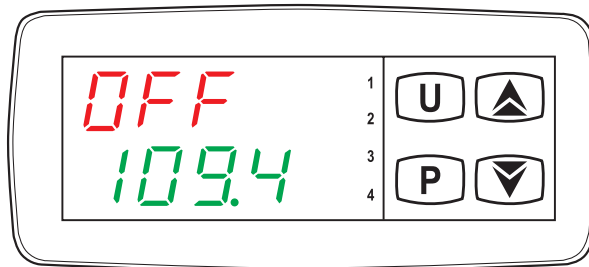

Figure 21: Control OFF Display

The upper display alternates between the current reference temperature and *OFF*.
The current set point temperature appears on the lower display.

Note: The controller's automatic control is now switched off. The calibrator's temperature will slowly decay to room temperature.

5.4.1.2 Switching On Automatic Control

Automatic control is switched off if the following display appears:

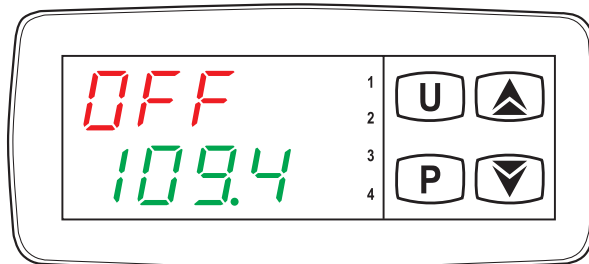

Figure 22: Control OFF Display

The upper display alternates between the current reference temperature and *OFF*.
The current set point temperature appears on the lower display.

To switch on automatic control:

1. Press the **P** key when in calibration mode for approximately 5 seconds. The main menu opens.

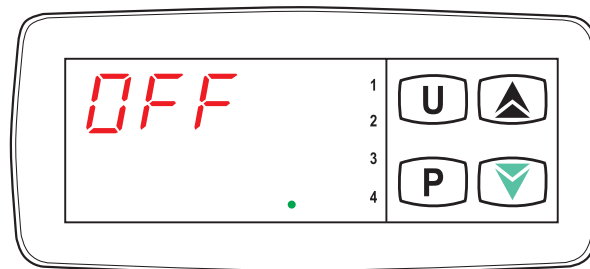

Figure 23: Control OFF Menu

OFF appears on the upper display.

LED SET flashes on the lower display.

2. Press the **▲** or **▼** key until the desired operating mode is displayed.
3. Press the **P** key to confirm.

Note: The controller is now switched on. The controller will enter into calibration mode. The calibrator's temperature will regulate to the desired set point temperature.

5.4.2 Manual Control

It is possible to switch off the automatic control of the calibrator and achieve the desired temperature via manual control.

5.4.2.1 Switching On Manual Control

1. Press the **P** key for approximately 5 seconds. The main menu opens.
The last selected function appears on the upper display.
LED SET flashes on the lower display.
2. Press the **▲** or **▼** key until *OPLO* (open loop) appears.

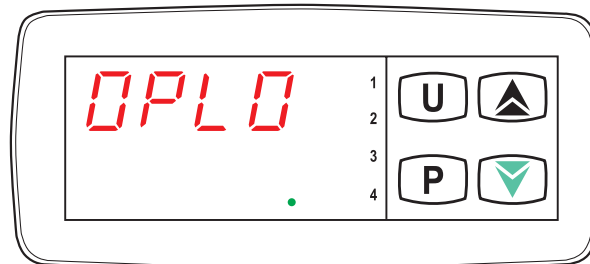

Figure 24: Manual Control (OPLO) Menu

OPLO appears on the upper display.

LED SET flashes on the lower display.

- Press the **P** key to confirm.

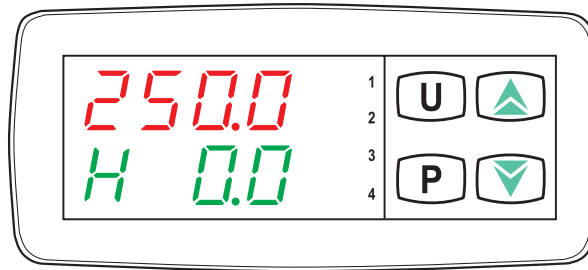

Figure 25: Manual Control (OPLO) Display

The current reference temperature appears on the upper display.

The letter *H* and the current percentage of heating capacity appear on the lower display.

- Press the **▲** key to increase the output capacity.
- Press the **▼** key to decrease the output capacity.

Note: Press the **▲** and **▼** key to raise and lower the value by 0.1 respectively. If the keys are held pressed for at least one second, the value increases or decreases quickly and after two seconds even more quickly; this means the desired value can be reached rapidly.

5.4.2.2 Switching Off Manual Control

Manual control is switched on if the following display appears:

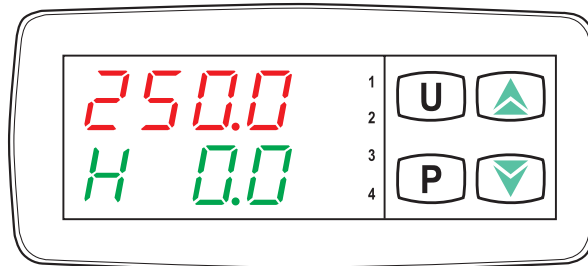

Figure 26: Manual Control (OPLO) Display

The current reference temperature appears on the upper display.

The letter *H* and the current percentage of heating capacity appear on the lower display.

To switch off manual control:

- Press the **P** key for approximately 5 seconds. The main menu opens.

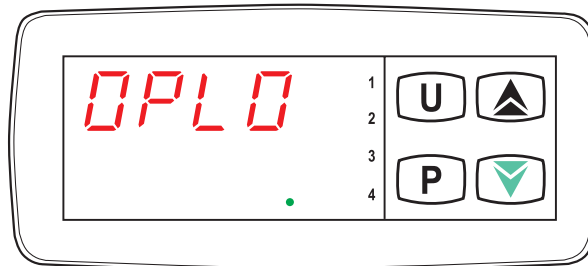

Figure 27: Manual Control (OPLO) Menu

OPLO appears on the upper display.

LED SET flashes on the lower display.

- Press the **▲** or **▼** key until the desired operating mode is displayed.
- Press the **P** key to confirm.

5.4.3 Set Point Memory

Up to four set point temperatures can be stored and retrieved from the set point memory.

5.4.3.1 Saving Set Point Temperatures

1. Press the **P** key when in calibration mode for approximately 5 seconds. The main menu opens.

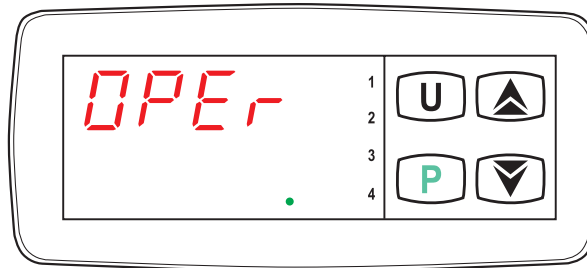

Figure 28: Operator (OPeR) Menu

OPeR (operator) appears on the upper display.

LED SET flashes on the lower display.

2. Press the **P** key again. The group level opens.

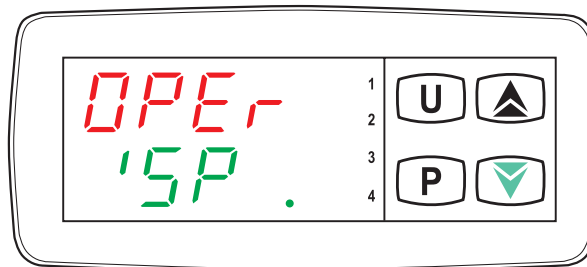

Figure 29: Group Level SP (Set Point)

OPeR appears on the upper display.

'SP (set point) appears on the lower display and LED SET flashes.

3. Press the **P** key again. The parameter level opens.

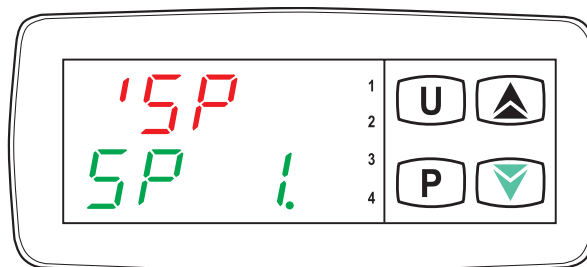

Figure 30: Parameter Level SP1 (Set Point 1)

'SP appears on the upper display.

SP 1 (set point 1) appears on the lower display and LED SET flashes.

4. Use the **▲** or **▼** key to select one of the four set point memories SP1, SP2, SP3 or SP4.

- Press the **P** key to open the respective set point memory.

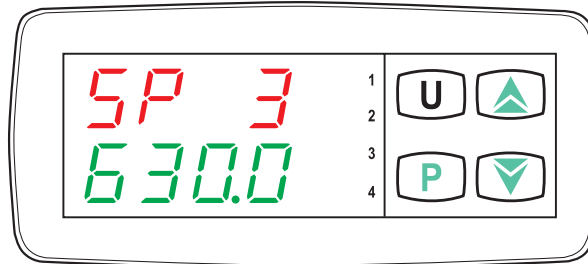

Figure 31: Set Point 3 Entry

The selected set point memory, e.g. SP3, flashes on the upper display.

The corresponding current set point temperature appears on the lower display.

- Press the **▲** key to increase the set point temperature.
- Press the **▼** key to decrease the set point temperature.

Note: Press the **▲** and **▼** key to raise and lower the value by 0.1 respectively. If the keys are held pressed for at least one second, the value increases or decreases quickly and after two seconds even more quickly; this means the desired value can be reached rapidly.

- Press the **P** key to confirm the set point temperature.
The set point memory closes and the display returns to the parameter level.

- Press and hold the **▼** or **▲** key to return to the calibration mode.

Note: If no key is pressed for approximately 15 seconds, the controller automatically returns to the calibration mode.

5.4.3.2 Retrieving Saved Set Point Temperatures

The saved set point temperatures can be retrieved in calibration mode.

- Press the **U** key when in calibration mode for approximately 2 seconds. The current set point memory opens.

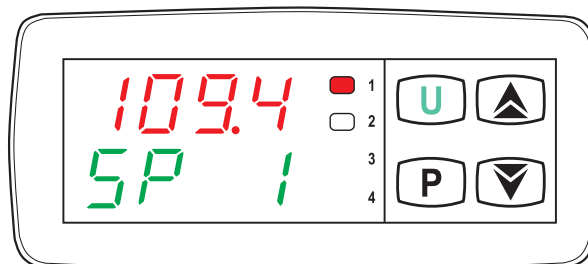

Figure 32: Set Point Retrieval (Showing Set Point Name)

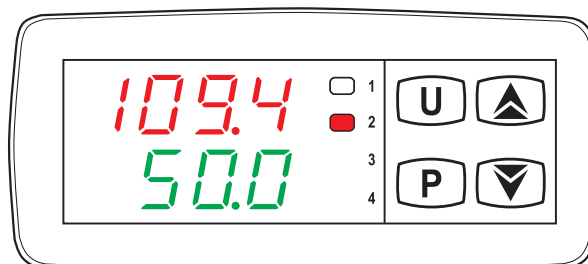

Figure 33: Set Point Retrieval (Showing Set Point Temperature)

The current reference temperature appears on the upper display.

The set point name (SP1, SP2, SP3 or SP4) appears on the lower display for 2 seconds followed by the current set point temperature.

2. To receive another saved set point, e.g. SP1, SP2, SP3 or SP4, press the **U** key again.
3. The selected temperature value is immediately adopted and targeted.

5.4.4 Gradient Control / Temperature Profile

Gradient control actively controls the rate of change ($^{\circ}\text{C}/\text{min}$) of the calibrator's temperature. A temperature profile is a combination of a heating gradient SL_{or} , duration time $dur.t$ and cooling gradient SL_{oF} .

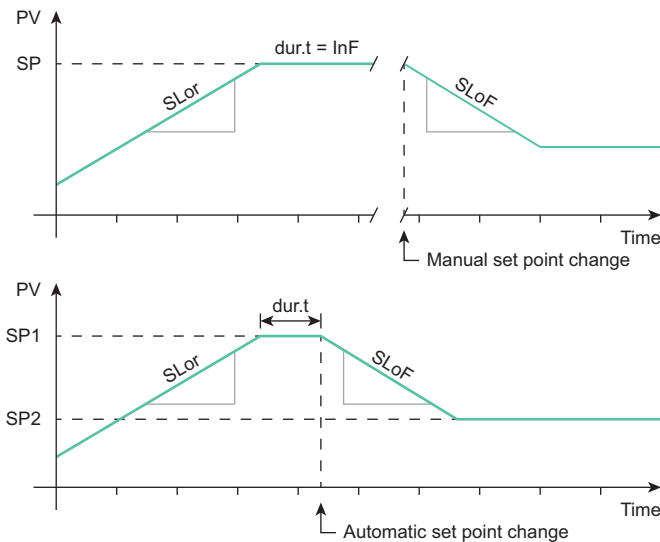

Figure 34: Gradient Control in a Temperature Profile

The heating gradient SL_{or} is active if the reference temperature is lower than the set point temperature. Each model of calibrator type has a maximum heating capacity. Only gradient settings less than the heating capacity can be achieved.

The cooling gradient SL_{oF} is active if the reference temperature is higher than the set point temperature. Each model of calibrator type has a maximum cooling capacity. Only gradient settings less than the cooling capacity can be achieved.

The calibrator can be configured to:

- a. Immediately switch to set point SP2 as soon as set point SP1 has been reached, or
- b. Switch to SP2 after duration time $dur.t$, after SP1 has been reached.

When using gradient control, it is possible to determine the time at which the set point temperature is reached.

See Table 5 for the heating and cooling capacity of the DryTC and LiquidTC calibrators.

Table 5: Calibrator Maximum Heating and Cooling Capacity

Model	Heating Capacity	Cooling Capacity	
DryTC165	7 °C/min (12.6 °F/min)		5 °C/min (9 °F/min)
DryTC650	35 °C/min (63 °F/min)	[650 °C to 300 °C] (1202 °F to 572 °F)	10 °C/min (18 °F/min)
		[300 °C to 100 °C] (572 °F to 212 °F)	5 °C/min (9 °F/min)
LiquidTC165	3 °C/min ^a (5.4 °F/min)		6 °C/min ^a (10.8 °F/min)
	5 °C/min ^b (9 °F/min)		4 °C/min ^b (7.2 °F/min)
LiquidTC255	22 °C/min ^c (39.6 °F/min)	[200 °C to 50 °C] (392 °F to 122 °F)	4 °C/min ^c (7.2 °F/min)
		(50 °C to 30 °C) (122 °F to 86 °F)	0.5 °C/min ^c (0.9 °F/min)
	12 °C/min ^b (21.6 °F/min)	(90 °C to 50 °C) (194 °F to 122 °F)	2 °C/min ^b (3.6 °F/min)
		(50 °C to 30 °C) (122 °F to 86 °F)	0.5 °C/min ^b (0.9 °F/min)

- a. Silicone oil 10 cSt.
- b. Distilled water.
- c. Silicone oil 50 cSt.

5.4.4.1 Heating and Cooling Gradient Parameter Level

The heating and cooling gradients and duration time can be set in parameter level 'r EE (regulation).

1. Press the **P** key for approximately 5 seconds. The main menu opens.
The last selected function appears on the upper display.
LED SET flashes on the lower display.
2. Press the **▲** or **▼** key until *OPER* (operator) is displayed.
3. Press the **P** key again. The group level opens.

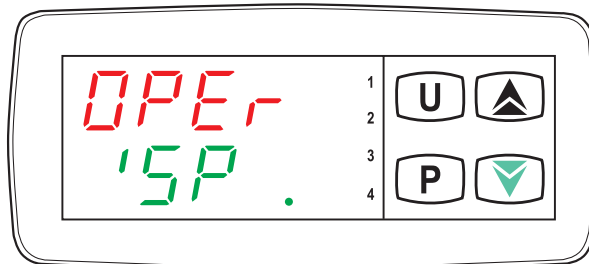



Figure 35: Group Level SP (Set Point)

OPER appears on the upper display.

'SP (set point) appears on the lower display and LED SET flashes.

4. Press the  key to select group level 'rEG.

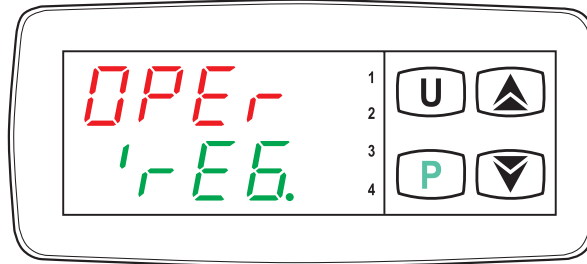



Figure 36: Group Level 'rEG (Regulation)

OPER appears on the upper display.

'rEG appears on the lower display and LED SET flashes.

5. Press the  key again. The parameter level opens.

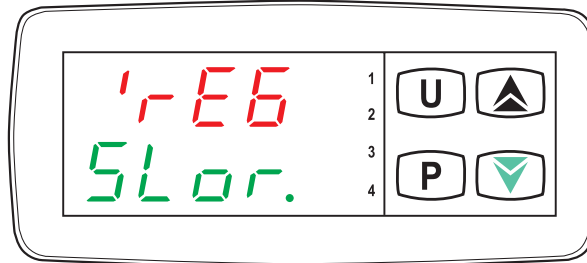

Figure 37: Parameter Level SLor (Heating Gradient)

'rEG appears on the upper display.

SLor flashes on the lower display.

5.4.4.2 Setting the Heating Gradient

The heating gradient *SLor* is active if the reference temperature is lower than the set point temperature.

The heating gradient is adjustable from 99.99 °C/min to 0.00 °C/min. See Table 5 for the maximum heating capacity of the calibrator.

Note: If *SLor* = INF (in no function), heating gradient control has been disabled.

1. Enter the gradient control parameter level. See Section 5.4.4.1.

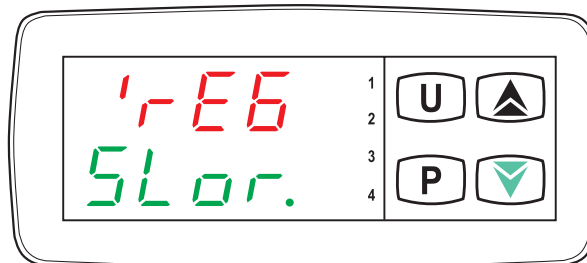

Figure 38: Parameter Level SLor (Heating Gradient)

'rEG appears on the upper display.

SLor flashes on the lower display.

- Press the **P** key.

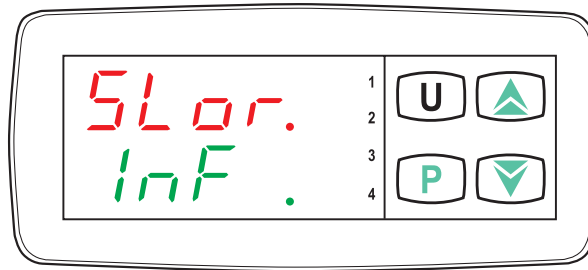

Figure 39: Heating Gradient (SLor) Entry

SLor flashes on the upper display.

The current heating gradient appears on the lower display.

- Press the **▲** key to increase the heating gradient.
- Press the **▼** key to decrease the heating gradient.

Note: Press the **▲** and **▼** key to raise and lower the value by 0.1 respectively. If the keys are held pressed for at least one second, the value increases or decreases quickly and after two seconds even more quickly; this means the desired value can be reached rapidly.

- Press the **P** key to confirm the heating gradient.

The display returns to the parameter level.

Note: If no key is pressed for approximately 15 seconds, the controller automatically returns to the calibration mode.

Note: See Section 5.4.4.5 for details on new heating gradient parameter activation.

5.4.4.3 Setting the Cooling Gradient

The cooling gradient *SLoF* is active if the reference temperature is higher than the set point temperature.

The cooling gradient is adjustable from 99.99 °C/min to 0.00 °C/min. See Table 5 for the maximum cooling capacity of the calibrator.

Note: If *SLoF* = *Inf* (in no function), cooling gradient control has been disabled.

- Enter the gradient control parameter level. See Section 5.4.4.1.

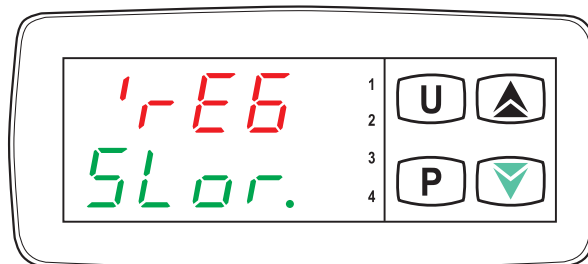



Figure 40: Parameter Level SLor (Heating Gradient)

rEE appears on the upper display.

SLor flashes on the lower display.

- Press the  or  key to select the *SLoF* parameter.

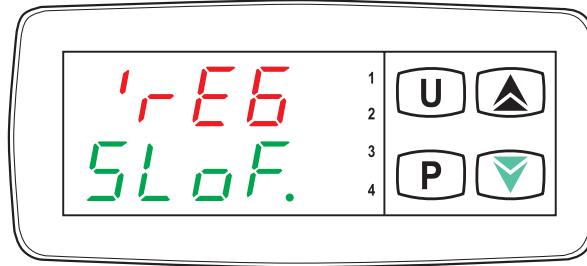



Figure 41: Parameter Level SLoF (Cooling Gradient)

rEE appears on the upper display.

SLoF flashes on the lower display.

- Press the  key.

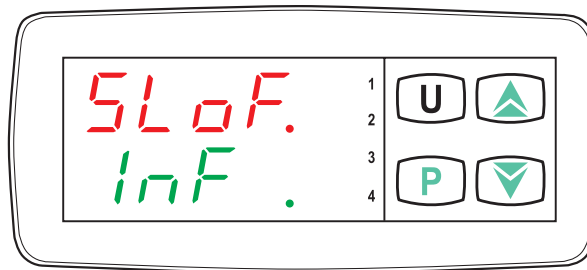







Figure 42: Cooling Gradient (SLoF) Entry

SLoF flashes on the upper display.

The current cooling gradient appears on the lower display.

- Press the  key to increase the cooling gradient.
- Press the  key to decrease the cooling gradient.

Note: Press the  and  key to raise and lower the value by 0.1 respectively. If the keys are held pressed for at least one second, the value increases or decreases quickly and after two seconds even more quickly; this means the desired value can be reached rapidly.

- Press the  key to confirm the cooling gradient.
The display returns to the parameter level.

Note: If no key is pressed for approximately 15 seconds, the controller automatically returns to the calibration mode.

Note: See Section 5.4.4.5 for details on new cooling gradient parameter activation.

5.4.4.4 Setting the Duration Time

Duration time *dur.t* is active once set point SP1 has been reached. After *dur.t* has expired, the controller will regulated to set point SP2.

The duration time is adjustable from 99:99 [hh:mm] to 00:00 [hh:mm].

Note: If *dur.t* = *Inf* (in no function), duration time has been disabled.

1. Enter the gradient control parameter level. See Section 5.4.4.1.

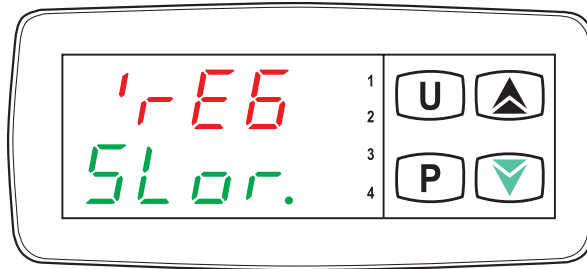

Figure 43: Parameter Level SLor (Heating Gradient)

rEE appears on the upper display.

SLor flashes on the lower display.



2. Press the  or  key to select the *dur.t* parameter.



Figure 44: Parameter Level dur.t (Duration Time)

rEE appears on the upper display.

dur.t flashes on the lower display.

3. Press the  key.

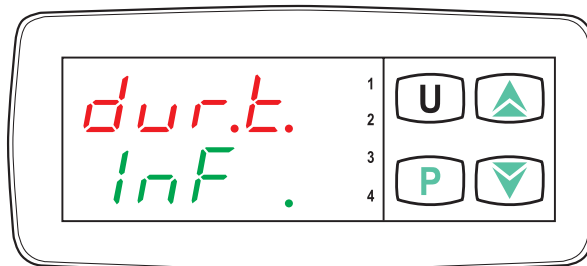







Figure 45: Duration Time (dur.t) Entry

dur.t flashes on the upper display.

The current duration time appears on the lower display.

4. Press the  key to increase the duration time.
5. Press the  key to decrease the duration time.

Note: Press the  and  key to raise and lower the value by 0.1 respectively. If the keys are held pressed for at least one second, the value increases or decreases quickly and after two seconds even more quickly; this means the desired value can be reached rapidly.

6. Press the  key to confirm the duration time.
The display returns to the parameter level.

Note: If no key is pressed for approximately 15 seconds, the controller automatically returns to the calibration mode.

Note: See Section 5.4.4.5 for details on new duration time parameter activation.

5.4.4.5 Heating and Cooling Gradient Parameter Activation

The calibrator uses the new gradient control settings or temperature profile when:

- The set point temperature is changed.
- The calibrator is switched off and back on again.
- The controller is changed to manual mode and then changed back to automatic mode. See Section 5.4.2.

5.5 Remote Control

The DryTC / LiquidTC can be controlled remotely using the RS 485 MODBUS interface, refer to Figure 1 item 4. For more information on the temperature calibrator communications protocol, refer to Druck document K0552.

Option accessory TCUSB converts the RS 485 output from the temperature calibrator into USB. A virtual PC communications port software driver for TCUSB can be downloaded from the following link: <https://ftdichip.com/drivers/vcp-drivers/>

6. Testing Process / Calibration



HOT SURFACE The calibrator may become very hot when in operation. Touching hot parts can result in serious injuries.

Never touch the dry block, micro bath, inserts or the DUT at temperatures above 35 °C (95 °F) or below 10 °C (50 °F).

Allow the calibrator to cool before you remove the DUT, change the insert or switch off the calibrator.



INFORMATION For optimum performance, allow the calibrator to warm up for at least an hour before use.

6.1 Testing Temperature Sensors



INFORMATION Earthed thermocouples cannot be calibrated. The dry block is earthed. The resulting short-circuit leads to incorrect measurements.

A separate temperature measuring instrument is required to measure the output of the DUT. The output of the DUT is compared to the temperature of the calibrator. The reference temperature, derived from the calibrator's internal temperature sensor, is used for the calibration comparison.

Note: The DUT requires a short period of time to equalize with the temperature of the dry block or micro bath.

6.2 Testing Procedure

6.2.1 Before Starting

Before starting the testing process, check that:

- The calibrator has a suitable installation site and operational position. See Section 4.1.
- The electrical connections have been made correctly. See Section 4.2.
- The correct insert has been selected for the testing. See Section 4.3.
- The insert is clean and dry.

Note: Ice and condensation can be removed from the insert by gently heating above 100 °C (212 °F).

5. The DUT is held securely in the calibrator.
6. The calibrator has sufficient structural stability.

6.2.2 Performing the Testing

During the testing process, one or more test points are selected and the reference temperature of the calibrator is compared with the measured temperature of the DUT.

1. Select the first set point temperature.
2. The controller regulates the dry block or micro bath to the required temperature.
3. Wait until the temperature has been reached and is sufficiently stable.
4. Verify that the temperature output measurement of the DUT is stable.
5. Record the reference temperature of the calibrator and the temperature output measurement of the DUT.
6. Select the next set point temperature and repeat from step 2.

6.2.3 Canceling the Testing

If the testing has to be canceled, the calibrator must be brought to a safe operational state.

1. Set the set point temperature to a low value, e.g. room temperature.
Note: Do not leave the calibrator unattended at high temperatures. See Section 4.4.2.
2. Wait until the calibrator has cooled down sufficiently.

6.2.4 After the Testing

1. Allow the calibrator to cool to room temperature. See Section 4.4.2.
2. If necessary, drain the micro bath or tub insert with the syringe.
3. Clean the calibrator. See Section 8.3.

7. Troubleshooting



PREVENT FAILURE Never open the calibrator. Critical parts or components may be damaged. Return the calibrator to Druck.

Refer to Table 6 for trouble shooting guide.

Table 6: Troubleshooting Guide

Problem	Possible Cause	Remedy
----	Disconnection of the internal reference sensor, or the internal reference sensor is defective.	
UUUU	Internal reference sensor under-range. [< -200 °C (-392 °F)]	Contact Druck Services.
OOOO	Internal reference sensor over-range. [> +850 °C (+1562 °F)]	
E-EP	Possible fault in the controller EEPROM memory.	Press the  key.

Table 6: Troubleshooting Guide

Problem	Possible Cause	Remedy
Fan not running.	The fan is defective or blocked.	
	The thermal protection fuse has tripped.	
Set point temperature is not achieved.	Solid state relay is defective.	Contact Druck Services.
	The heating / cooling element is defective.	
No display.	Controller is defective.	
Calibrator cannot be switched on.	Mains not available or fuses blown.	Check the mains supply and the fuses.
	Residual current circuit breaker has tripped due to moisture in the heating elements.	Contact Druck Services.

If you are unable to remedy the problem, immediately disconnect the calibrator to protect against unintended operation. Return the calibrator to Druck for repair.

8. Maintenance, Cleaning and Transportation

Before maintenance, cleaning and transportation, ensure:

1. The calibrator has cooled sufficiently. See Section 4.4.2.
2. The calibrator has been switched off and disconnected from the mains.

8.1 Maintenance



PREVENT FAILURE Never open the calibrator. Critical parts or components may be damaged. Return the calibrator to Druck.

The calibrator is maintenance-free and cannot be repaired by the user. In case of a defect, the calibrator must be returned to Druck, or approved service representative for repair.

For safe operation of the calibrator, the following checks must be carried out at regular intervals.

8.1.1 Before Use

1. Check the calibrator for damage.
2. For micro bath calibrators, check the filled height of the calibration liquid. See Section 4.3.3.8.

8.1.2 Annually

1. Visually inspect all parts of the calibrator for corrosion, wear and damage.
2. Have a trained technical person carry out an electrical safety inspection.

8.1.3 Recalibration

It is recommended to send the calibrator to Druck for recalibration after 36 months, or after a maximum of 500 operating hours, whichever is sooner.

8.1.4 Calibration Liquid

Calibration liquids become contaminated with age and with use. The speed at which this occurs depends greatly on the type of liquid and the usage behavior.

1. Replace contaminated or aged calibration liquid.

8.1.5 Magnetic Stirrer

The magnetic stirrer is subject to mechanical wear and tear during normal operation. The magnetic stirrer has a limited lifetime and requires periodic replacement. The fillet in the middle of the magnetic stirrer reduces the friction during the rotary movement. Once the fillet has worn, the stirring function can no longer be guaranteed because of the increased friction.

1. Check the fillet of the magnetic stirrer for wear and tear. Replace the magnetic stirrer if necessary.

8.1.6 Mains Fuses



WARNING Only use fuses of the same type.

For fuse specification, see Section 10.

The mains fuses of the calibrator are located on the front side and are integrated in the mains connection. If mains voltage is present, but the display is dark and the fan is not running, check the mains fuses. Replace the fuses if necessary.

1. Disconnect the mains connection cable from the calibrator.
2. Prise open the fuse compartment from the bottom with a fingernail or a flat screwdriver.
3. Remove the compartment with the fuses.
4. Check the fuses and replace any blown fuses.

Note: Always replace both fuses, even if only one has blown.

5. Fit the fuse compartment back in place and connect the mains connecting cable. See Section 4.2.

Note: Should the fuses blow repeatedly, there is probably a fault with the calibrator. Send the calibrator to Druck for repair.

8.2 Recalibration

The calibrator is adjusted and tested with measuring equipment in accordance with recognized national standards prior to delivery.

The calibrator should, depending on the application situation, be inspected at appropriate intervals on the basis of ISO 10012.

It is recommended to send the calibrator to Druck for recalibration after 36 months, or after a maximum of 500 operating hours, whichever is sooner.

8.3 Cleaning

8.3.1 Exterior Chassis

Clean the calibrator with a dry or slightly damp lint-free cloth. Do not use sharp objects or aggressive agents for cleaning.

Ensure that your cleaning agent cannot be a source of danger from a reaction with parts of the calibrator or the materials inside. If unsure of clean agent compatibility, contact Druck Services.

8.3.2 Vent Grilles for Inlet Air



INFORMATION If the vent grilles become obstructed, the thermal protection fuse may trip. The thermal protection fuse is non-resettable. The calibrator cannot be used anymore. The calibrator must be returned to Druck for repair. Ensure that the grille openings are always kept clear.

The grille openings, see Figure 1 items 11 and 12, in the base of the calibrator must be cleaned at regular intervals. The cleaning interval depends upon on the air pollution at the installation site and the amount of use.

1. Clean the grille openings by vacuuming or brushing.

8.3.3 Inserts



INFORMATION Before a prolonged shutdown of the calibrator, remove the insert from the dry block or micro bath.

During normal operation, the inserts create small quantities of metal dust. This can result in an insert getting stuck in the dry block.

1. Remove the insert from the dry block with the aid of the sleeve exchange tool.
2. Clean the insert and the dry block at regular intervals.

8.3.4 Micro Bath

Before cleaning, the micro bath must be drained as much as possible using the draining syringe. Observe the instructions in the safety data sheet of the calibration liquid.

8.3.4.1 Distilled Water

1. Remove the sensor cage from the tank.
2. Remove the magnetic stirrer with the aid of the magnetic lifter.
3. Thoroughly dry the micro bath, sensor cage, magnetic stirrer and the draining syringe.

8.3.4.2 Silicone Oil

1. Remove the sensor cage from the micro bath.
2. Remove the magnetic stirrer with the aid of the magnetic lifter.
3. Clean the micro bath, sensor cage, magnetic stirrer with water to which a generous amount of detergent has been added.
4. Remove the soapy water as much as possible using the draining syringe.
5. Thoroughly dry the micro bath, sensor cage, magnetic stirrer and the draining syringe.

8.4 Return Goods/Material Procedure

If the unit requires calibration or is unserviceable, return it to the nearest Druck Service Centre listed at: <https://druck.com/service>.

Contact the Service Department to obtain a Return Goods/Material Authorization (RGA or RMA). Provide the following information for a RGA or RMA:

- Product (e.g. DryTC650).
- Serial number.
- Details of defect/work to be undertaken.
- Include any error code(s).
- Operating conditions.

8.4.1 Safety Precautions



INFORMATION Service by unauthorized sources will affect the warranty and may not guarantee further performance.

You must inform Druck if the product has been in contact with any hazardous or toxic substance. The relevant COSHH or in the USA, MSDS, references and precautions to be taken when handling.

9. Decommissioning and Disposal

9.1 Before Decommissioning

Prior to decommissioning, ensure that:

1. The measurement set up is switched off and is in a safe de-energized state.
2. The calibrator and its accessories have completely cooled down. See Section 4.4.2.

9.2 Decommissioning

1. Remove all connected sensors and devices.
2. Switch off the calibrator and disconnect the mains plug.
3. Empty the micro bath of residual calibration liquid. See Section 8.3.4.

9.3 Disposal of Calibration Liquid



CAUTION Dispose of the calibration liquid in accordance with the Technical Safety Data Sheet.

9.4 Disposal of Calibrator

See “Marks and Symbols on the Equipment” on page ii for details of the Druck WEEE take-back scheme.

10. Specification

10.1 Shared Specification

Specification	DryTC and LiquidTC Models
Calibrator:	
Influence of the operating temperature [0 °C to 50 °C (32 °F to 122 °F)] on the accuracy.	± 0.02 °C/°C (0.036 °F/°F)
Resolution reference temperature setting range.	0.1 °C/F
Detection speed.	130 ms
Display:	
Resolution	0.01 °C/F (-9.99 to 99.99), or 0.1 °C/F
Display units.	°C or °F (optional)
Two-line display: - Reference temperature - Target temperature	4-digit, 7-segment LED, 7 mm (0.28") high red = upper display, green = lower display
Display for sensor failure.	- - - -
Sensor failure behavior.	The control is switched off.
Excess temperature behavior.	Thermal fuses interrupt the power supply on excessive temperature inside the housing.
Temperature Control:	
Controller outputs:	
- Heater control	Solid state relay.
- Cooler control	Solid state relay.
- Fan control	Mechanical relay (lifetime = 100,000 switching cycles)
Environmental:	
Ingress protection rating.	IP 20
Operating temperature range.	0°C to 50 °C (32°F to 122 °F)
Relative humidity.	30 % to 95 % RH (none condensing)
Transportation and storage temperature.	-10 °C to 60 °C (14 °F to 140 °F)

10.2 DryTC Specification

Specification	DryTC165	DryTC650
Calibrator:		
Temperature range.	-35 °C to 165 °C (-31 °F to 329 °F)	T _R to 650 °C (T _R to 1202 °F)
Accuracy	± 0.2 °C (± 0.36 °F)	± 0.4 °C (± 0.72 °F)
Stability		± 0.05 °C (± 0.09 °F)
Display range.	-50 °C to 165 °C (-58 °F to 329 °F)	0 °C to 650 °C (32 °F to 1202 °F)
Electrical Characteristics:		
Power supply:		
- Voltage range.	100 Vac to 240 Vac	
- Frequency	50 / 60 Hz	
Power consumption.	375 W	1000 W
Fuses	2 off 5 × 20 mm T6.3H250V	2 off 5 × 20 mm T10H250V
Serial interface:		
- Interface type.	RS 485 optoisolated	
- Communication protocol.	MODBUS RTU (JBUS)	
- Serial transfer speed.	9600 Baud	
Dimensions:		
Dry block:		
- Bore diameter	28 mm (1.10")	
- Depth	150 mm (5.91")	
- Measurement zone.	Adaptor sleeve: 110 mm to 150 mm (4.33" to 5.91") Infrared: 110 mm (4.33")	
Housing dimensions:		
- Width	210 mm (8.27")	150 mm (5.91")
- Height + Handle	380+50 mm (15.0+2.0")	330+70 mm (13.0+2.8")
- Depth	300 mm (11.8")	270 mm (10.6")
- Weight	~ 10.0 kg (~ 22.1 lbs)	~ 7.5 kg (~ 16.5 lbs)

10.3 LiquidTC Specification

Specification	LiquidTC165	LiquidTC255
Calibrator:		
Temperature range:		
- Micro bath (water)	2 °C to 95 °C (35.6 °F to 203 °F)	T _R to 95 °C (T _R to 203 °F)
- Micro bath (silicone oil)	-35 °C to 165 °C (-31 °F to 329 °F)	T _R to 255 °C (T _R to 491 °F)
Accuracy	± 0.1 °C (± 0.18 °F)	± 0.2 °C (± 0.36 °F)
Stability		± 0.05 °C (± 0.09 °F)
Display range.	-50 °C to 165 °C (-58 °F to 329 °F)	0 °C to 255 °C (32 °F to 491 °F)
Electrical Characteristics:		
Power supply:		
- Voltage range.	100 Vac to 240 Vac	100 Vac to 230 Vac
- Frequency	50 / 60 Hz	
Power consumption.	375 W	1000 W
Fuses	2 off 5 × 20 mm T6.3H250V	2 off 5 × 20 mm T10H250V
Serial interface:		
- Interface type.	RS 485 optoisolated	
- Communication protocol.	MODBUS RTU (JBUS)	
- Serial transfer speed.	9600 Baud	
Dimensions:		
Dry block:		
- Bore diameter	60 mm (2.36")	
- Depth	170 mm (6.69")	
- Measurement zone.	110 mm to 150 mm (4.33" to 5.91")	
- Sensor cage working depth.	150 mm (5.91")	
Housing dimensions:		
- Width	210 mm (8.27")	150 mm (5.91")
- Height + Handle	380+50 mm (15.0+2.0")	330+70 mm (13.0+2.8")
- Depth	300 mm (11.8")	270 mm (10.6")
- Weight	~ 12.5 kg (~ 27.6 lbs)	~ 7.5 kg (~ 16.5 lbs)

10.4 Heating and Cooling Times

Note: The heating and cooling times are dependent on the parameters of the test task and the ambient conditions.

The following times are guide values only. They are measured at a room temperature of 23 °C (73.4 °F) and do not include transient effects.

10.4.1 DryTC165

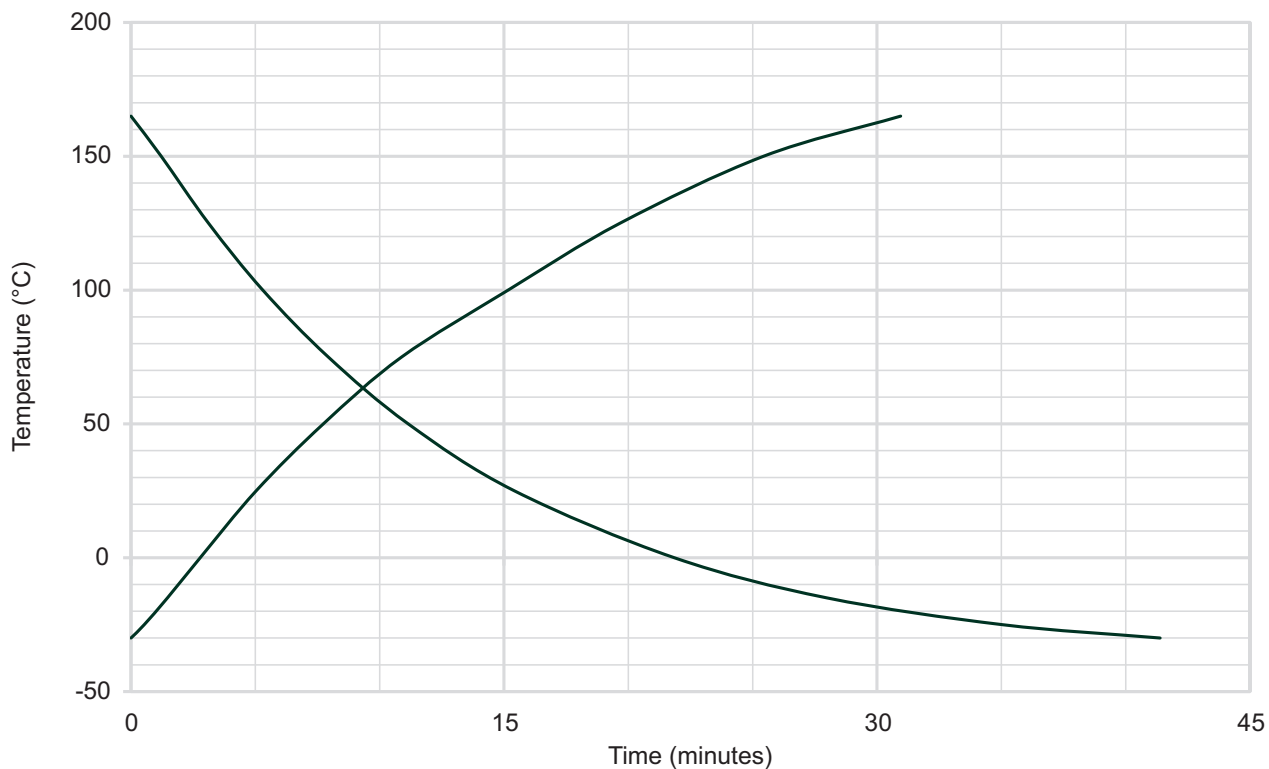

Figure 46: DryTC165 Heating and Cooling Times

10.4.2 DryTC650

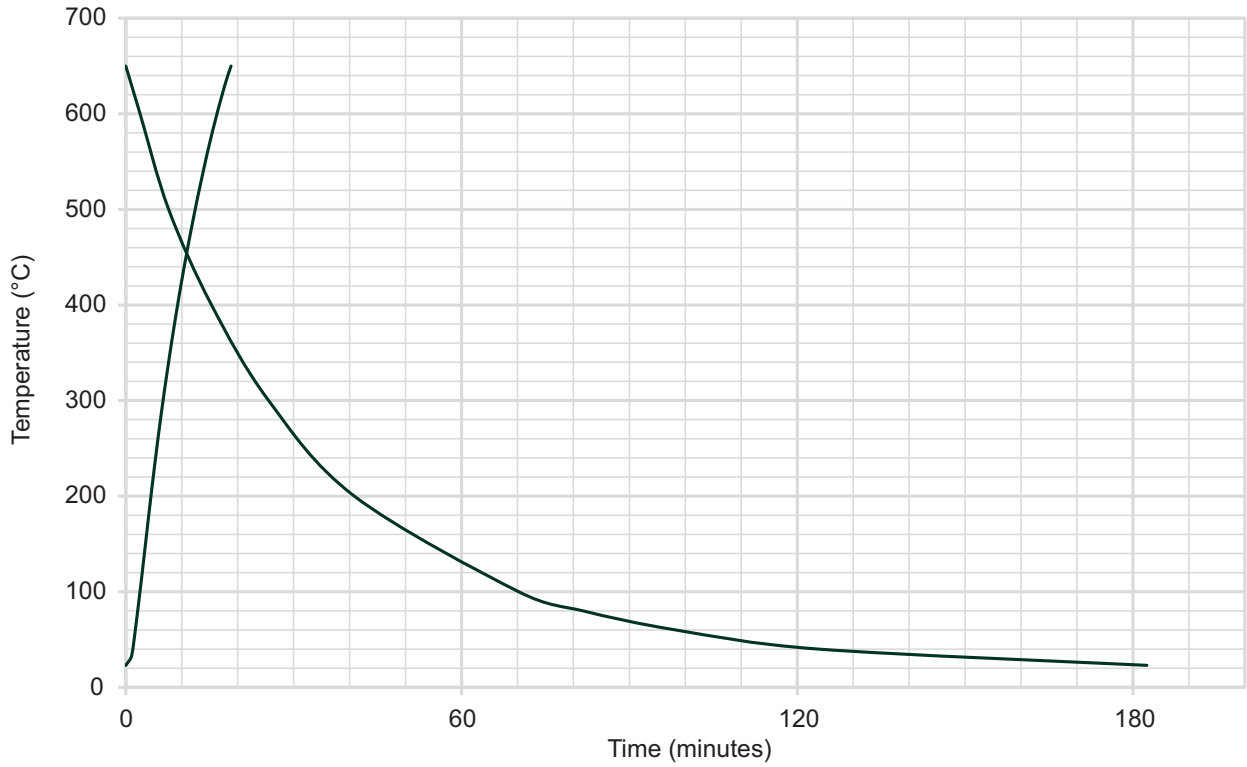

Figure 47: DryTC650 Heating and Cooling Times

10.4.3 LiquidTC165

10.4.3.1 Dry Block and Infrared Inserts

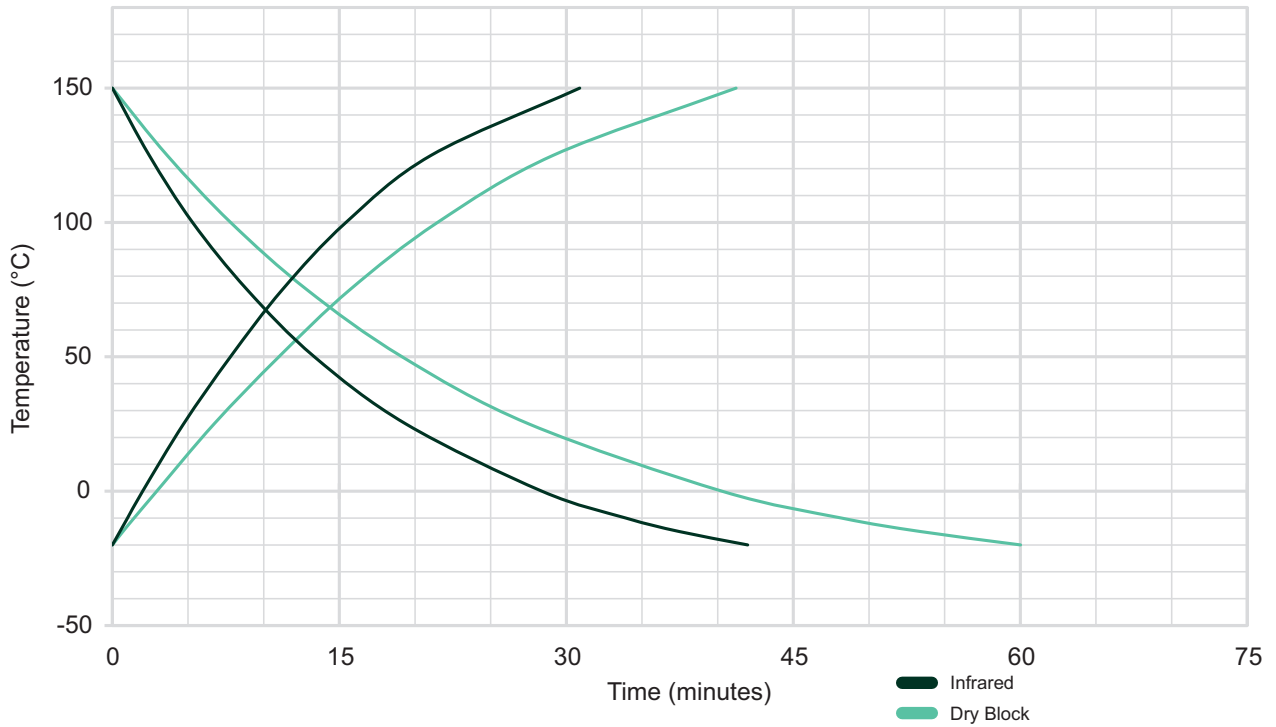

Figure 48: LiquidTC165 Heating and Cooling Times

10.4.3.2 Water and Silicone Oil

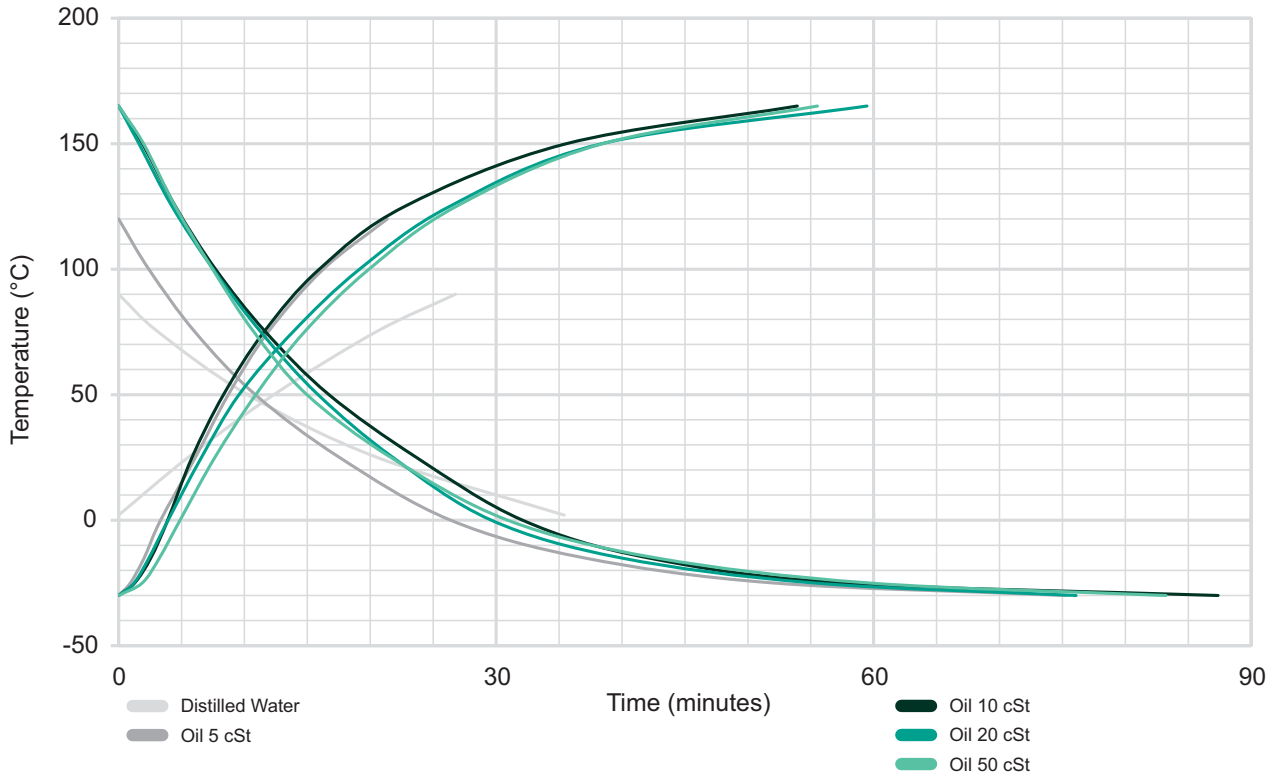

Figure 49: LiquidTC165 Heating and Cooling Times

10.4.4 LiquidTC255

10.4.4.1 Dry Block and Infrared Inserts

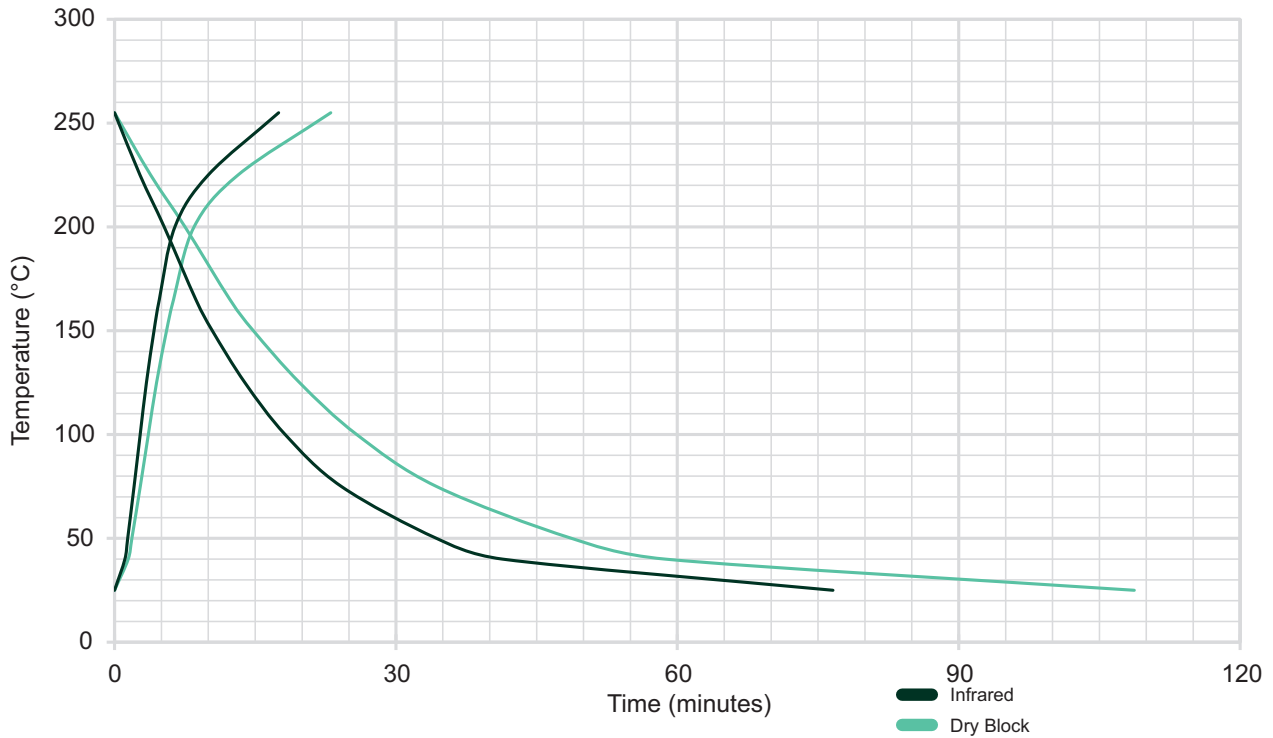

Figure 50: LiquidTC255 Heating and Cooling Times

10.4.4.2 Water and Silicone Oil

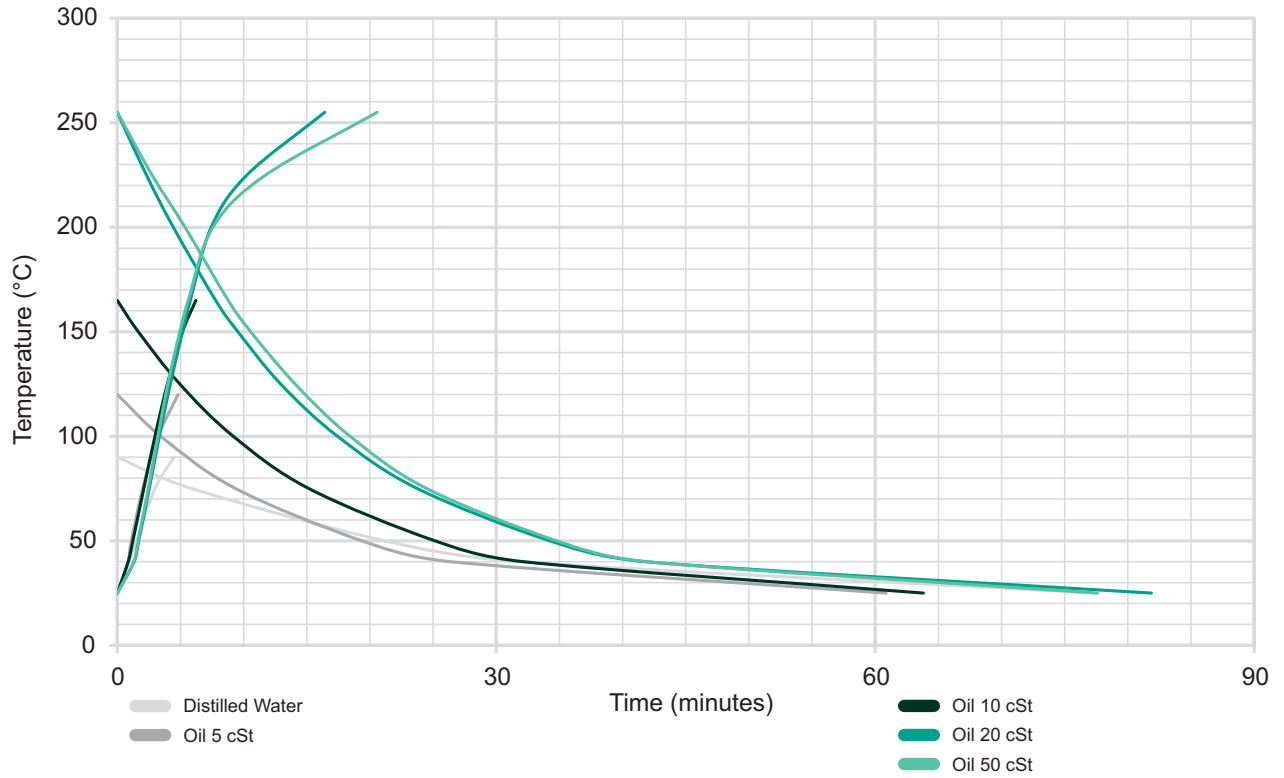

Figure 51: LiquidTC255 Heating and Cooling Times

Office Locations



<https://druck.com/contact>

Services and Support Locations



<https://druck.com/service>



www.sensycal.com.br

Avenida do Estado 4567
São Paulo, SP, Brasil - 03105-000
+55 (11) 3275 0094
vendas@sensycal.com.br